



# RX699-MT60

6.5 inch Coaxial Loudspeaker, 70 V

tq install™  
SERIES



## Overview

The RX699-MT60 is a high efficiency, high fidelity coaxial loudspeaker that provides output capability typical of a much larger loudspeaker. It includes a high quality, 60 watt multi-tap transformer and a 16 ohm direct input. The transducer's high efficiency and horn-loaded HF compression driver give the RX699-MT60 a surprisingly high output-to-size ratio, and its broad 90° x 90° coverage is particularly effective in close quarters. The RX699's compact enclosure may be mounted close to walls or ceilings, under balconies, or along a stage front with minimal effect on sight lines. Its small size also allows it to be readily concealed within a venue's architecture when the loudspeaker must be hidden from view.

Fulcrum Acoustic's TQ™ processing is an integral part of the RX699-MT60 design. Sound, innovative acoustical design combined with state of the art digital processing leads to exceptional clarity and precise transient response, even at very high sound pressure levels. The required digital signal processing can be provided by one of many supported platforms.

The RX699-MT60 is an excellent option any time moderately high SPLs are required but limited space is available. Spoken word sounds very natural, and the coaxial design assures that this remains so even off-axis. Low frequency extension to 87 Hz enables it to integrate well with subwoofers for full range music reproduction. The RX699-MT60 is a perfect choice for delay fill, background music, and speech reproduction systems, which makes it ideal for houses of worship, theaters, restaurants, nightclubs, museum kiosks, theme parks, and more.

## Performance Specifications<sup>1</sup>

### Operating Mode

Single-amplified w/ DSP

### Operating Range<sup>2</sup>

87 Hz to 20 kHz

### Nominal Beamwidth

90° x 90°

### Transducers

HF/LF: Coaxial 1.0" diaphragm compression driver, neodymium magnet; 6.5" woofer, 2.0" voice coil, ceramic magnet

### Power Handling @ Nominal Impedance<sup>3</sup>

53 V / 175 W @ 16 Ω

### Nominal Sensitivity @ Input Voltage<sup>4</sup> (whole space)

100 dB @ 4.00 V

### Nominal Maximum SPL (peak / continuous)

129 dB / 123 dB

### Equalized Sensitivity @ Input Voltage<sup>5</sup>

89 dB @ 4.00 V

### Equalized Maximum SPL<sup>6</sup> (peak / continuous)

118 dB / 112 dB

### Recommended Power Amplifier

175 W to 350 W @ 16 Ω

## Physical Specifications

### Connections

Multi-tap terminal strip:

70 V transformer: COM , 60 W , 30 W , 15 W

Direct: 16 Ω - , 16 Ω +

### Mounting / Suspension Points

(2) M6 yoke points,

(2) M6 nut plates for third-party pan/tilt mounts

### Dimensions / Weight

See page 5

### Finish

Black painted enclosure w/ matte black grille, or

White painted enclosure w/ matte white grille

## Options

RX699 U Bracket [YK1106], Custom color finish,

Weather-resistant (WR) enclosure



Axial Sensitivity (dB SPL, 4.00 V @ 1 m)<sup>7,8</sup>

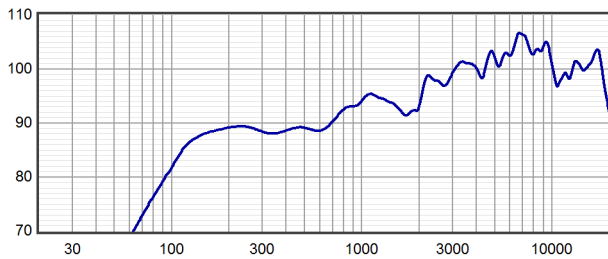

Horizontal Off Axis Response<sup>7,11</sup>

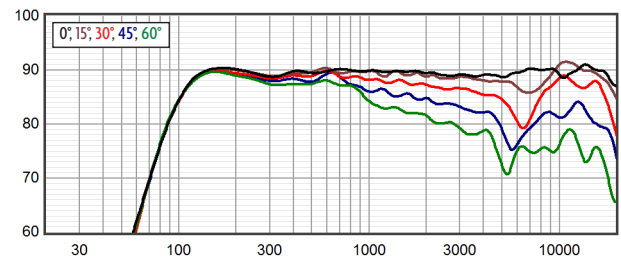

Axial Processed Response (dB)<sup>7,9</sup>

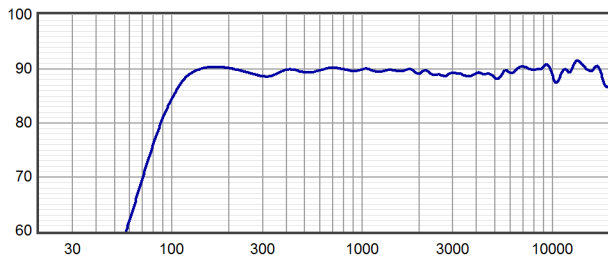

Vertical Off Axis Response<sup>7,11</sup>

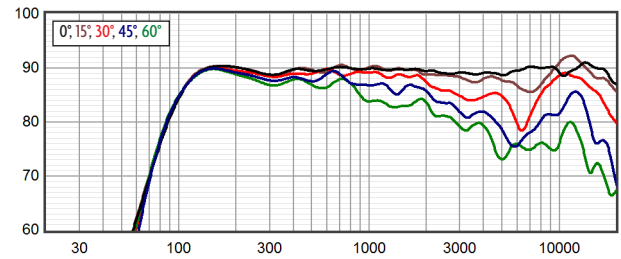

Axial Processed Phase Response (degrees)<sup>7,10</sup>

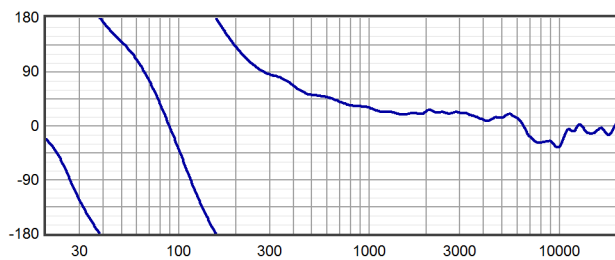

Beamwidth<sup>7,12</sup>

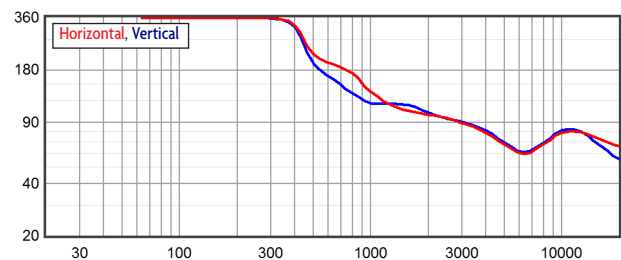

Impedance (ohms)

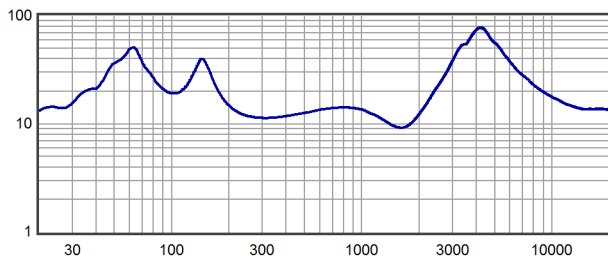

Directivity Index (dB)<sup>13</sup>

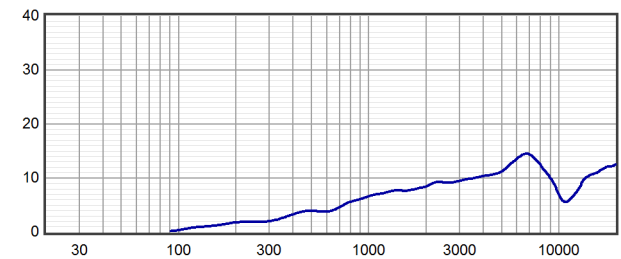



Horizontal Polar Response (30 dB Scale, 6 dB per Major Division)

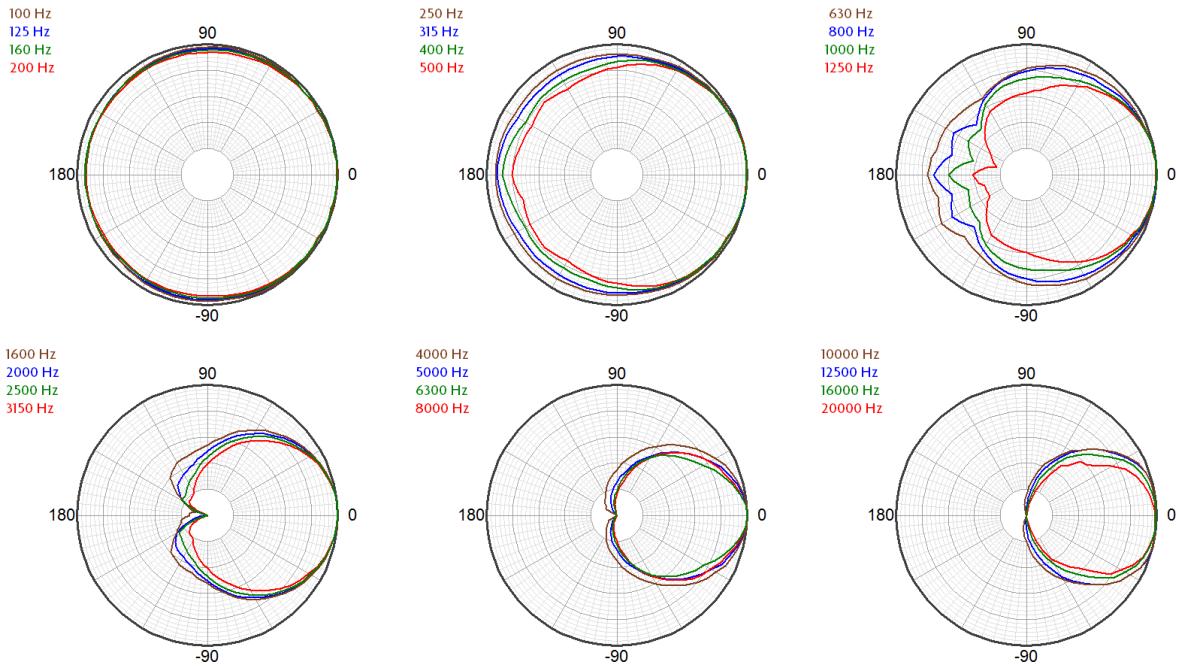

Vertical Polar Response (30 dB Scale, 6 dB per Major Division)

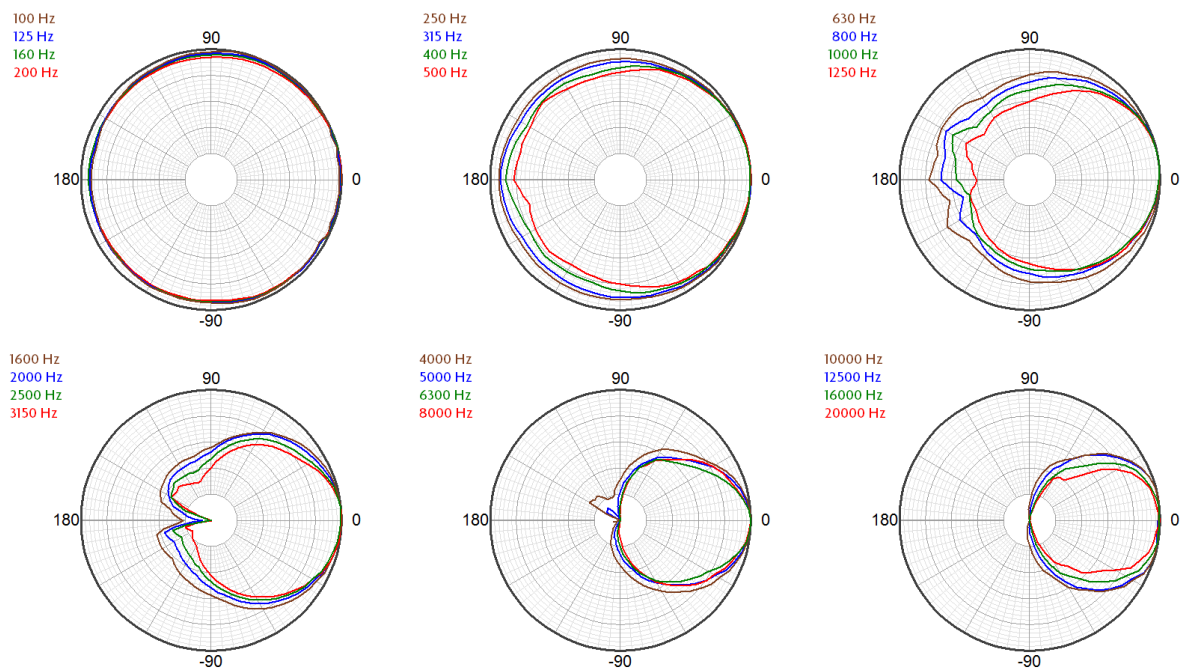



## Technologies

The RX699-MT60 includes a powerful ferrite-based low frequency section and a tightly integrated 1 inch neodymium compression driver, which positions the compression driver diaphragm very close to the woofer voice coil. This allows the system to maintain coherent summation and provide consistent off axis response through a passive crossover, allowing it to be powered with a single amplifier channel.

## Connection Diagram

2-way, Single-Amp, 70 V

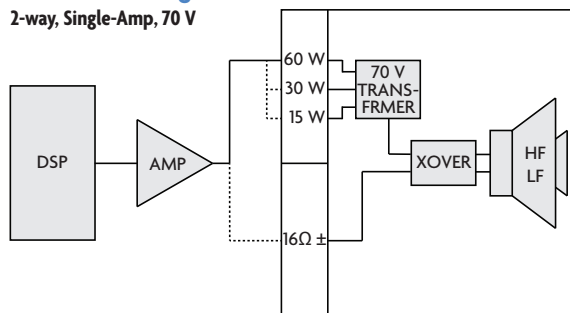

## Mechanical Specification Drawings

2D and 3D DXF dimensional drawings are available for download at [www.fulcrum-acoustic.com/support](http://www.fulcrum-acoustic.com/support).



## Notes

- <sup>1</sup> **Performance Specifications** All acoustic specifications rounded to nearest whole number. External DSP with Fulcrum Acoustic-provided settings is required to achieve the specified performance.
- <sup>2</sup> **Operating Range** The frequency range within which the processed response is within 10 dB of the average.
- <sup>3</sup> **Power Handling** Based on the AES power handling of the transducers.
- <sup>4</sup> **Nominal Sensitivity** The 1-meter-referenced SPL produced by a 1 watt band limited pink noise signal, with no processing applied.
- <sup>5</sup> **Equalized Sensitivity** The 1-meter-referenced SPL produced when an EIA-426-B signal is applied to an equalized loudspeaker system, at a level which produces a total power of 1 watt, in sum, to the loudspeaker subsections.
- <sup>6</sup> **Equalized Maximum SPL** The 1-meter-referenced SPL produced when an EIA-426-B signal is applied to an equalized loudspeaker system, at a level which drives at least one subsection to its rated power.
- <sup>7</sup> **Resolution** All response graphs are subjected to 1/6 octave cepstral smoothing with a gaussian weighting function.
- <sup>8</sup> **Axial Sensitivity** The SPL plotted against frequency for a 1 watt swept sine wave, referenced to 1 m with no signal processing.
- <sup>9</sup> **Axial Processed Response** The axial magnitude response with recommended signal processing applied.
- <sup>10</sup> **Axial Processed Phase Response** The axial phase response with recommended signal processing applied, and latency removed.
- <sup>11</sup> **Horizontal / Vertical Off Axis Responses** The magnitude response at various angles off axis, with recommended signal processing applied.
- <sup>12</sup> **Beamwidth** The angle between the -6 dB points in a loudspeaker's polar response.
- <sup>13</sup> **Directivity Index (Di)** The ratio of the on-axis sound pressure squared to the spherical average of the sound pressure squared at a particular frequency expressed in dB. To convert the directivity index to directivity factor (Q) use the formula  $10^{Di/10}$ .



product specification

Notes:

1. Net Weight = Approx. 13.0 lb / 5.9 kg
2. Ship Weight = Approx. 17.0 lb / 7.7 kg
3. Symbol  = M6 nut plate
4. 2x M6 nut plates on left side for third party pan/tilt mounts
5. Symbol  = CoG

REVISIONS

REV	DESCRIPTION	APPR / DATE
1	NEW ISSUE	RAF 11/23/11
2	OMNIMOUNT TO "THIRD PARTY" IN NOTE 4	RAF 1/13/12

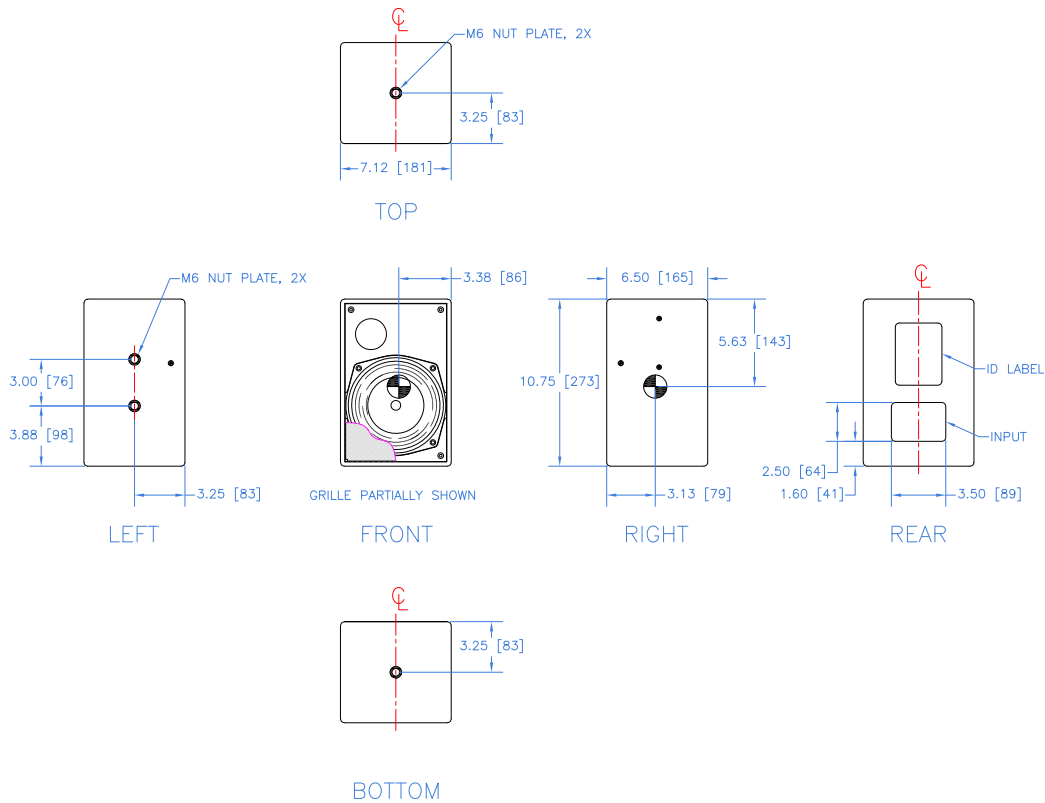

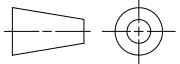
<p>THIRD ANGLE PROJECTION</p> 	<p>UNLESS OTHERWISE SPECIFIED: ALL DIMENSIONS ARE IN INCHES</p> <p>TOLERANCE IN INCHES .XX1 .XX±.015 .XXX±.005 FRACTIONS ±1/32 ANGLES ±1/2°</p> <p>(.XX) = REF DIMS NO TOLERANCE IMPLIED</p> <p>TSC = THEORETICAL SHARP CORNER</p> <p>DIMENSIONS ACROSS CENTERLINES TO BE SYMMETRICAL</p>	<p>STATUS RELEASED</p>		<p>FULCRUM ACOUSTIC, LLC 670 LINWOOD AVE., LINWOOD, MA 01525 USA</p>
		<p>APPROVALS</p> <p>DATE</p>	<p>DATE</p>	
<p>THIS DRAWING IS THE PROPERTY OF FULCRUM ACOUSTIC, AND SHALL NOT BE COPIED, REPRODUCED, OR USED AS THE BASIS FOR MANUFACTURE OR SALE OF APPARATUS WITHOUT WRITTEN AUTHORIZATION. DO NOT SCALE DRAWING.</p>	<p>DRAWN: RAF</p> <p>CHECKED: DWG</p> <p>DES ENG:</p> <p>MFG ENG:</p>	<p>DATE: 11/23/11</p> <p>DATE: 11/23/11</p>	<p>A</p> <p>DWG. NO. 820-100-054</p>	<p>SHEET 1 OF 1</p> <p>SCALE: 1:8</p> <p>REV 2</p>

Drawing is reduced. Do not scale.



product specification, weather-resistant (WR) version

Notes:

1. Net Weight = Approx. 13.0 lb / 5.9 kg
2. Ship Weight = Approx. 17.0 lb / 7.7 kg
3. Symbol = M6 nut plate
4. 2x M6 nut plates on left side for third party pan/tilt mounts
5. Symbol = CoG

REVISIONS		
REV	DESCRIPTION	APPR / DATE
1	NEW ISSUE	RAF 11/13/14
2	ADD ID LABEL	RAF 1/17/22

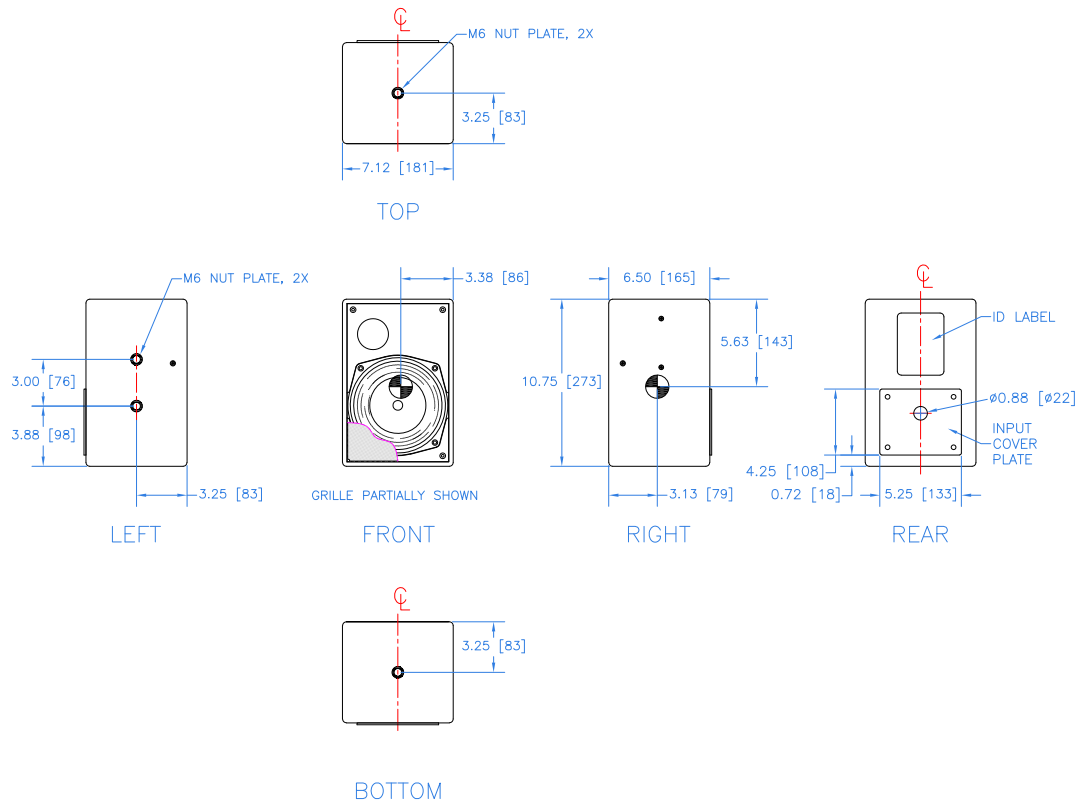

<p>THIRD ANGLE PROJECTION</p>	<p>UNLESS OTHERWISE SPECIFIED: ALL DIMENSIONS ARE IN INCHES</p> <p>TOLERANCE IN INCHES .XX±.015 .XXX±.005 FRACTIONS ±1/32 ANGLES ±1/2°</p> <p>(X.XX) = REF DIMS NO TOLERANCE IMPLIED</p> <p>TSC = THEORETICAL SHARP CORNER</p> <p>DIMENSIONS ACROSS CENTERLINES TO BE SYMMETRICAL</p>	<p>STATUS RELEASED</p>		<p>FULCRUM ACOUSTIC, LLC 670 LINWOOD AVE., LINWOOD, MA 01525 USA</p>
		<p>APPROVALS</p> <p>DATE</p>	<p>DATE</p>	
<p>THIS DRAWING IS THE PROPERTY OF FULCRUM ACOUSTIC, AND SHALL NOT BE COPIED, REPRODUCED, OR USED AS THE BASIS FOR MANUFACTURE OR SALE OF APPARATUS WITHOUT WRITTEN AUTHORIZATION. DO NOT SCALE DRAWING.</p>	<p>DRAWN: RAF</p> <p>CHECKED: DWG</p> <p>DES ENG:</p> <p>MFG ENG:</p>	<p>DATE: 11/13/14</p> <p>DATE: 11/13/14</p>	<p>A</p> <p>DWG. NO. 820-100-083</p>	<p>SHEET 1 OF 1</p> <p>SCALE: 1:8</p> <p>REV 2</p>

Drawing is reduced. Do not scale.

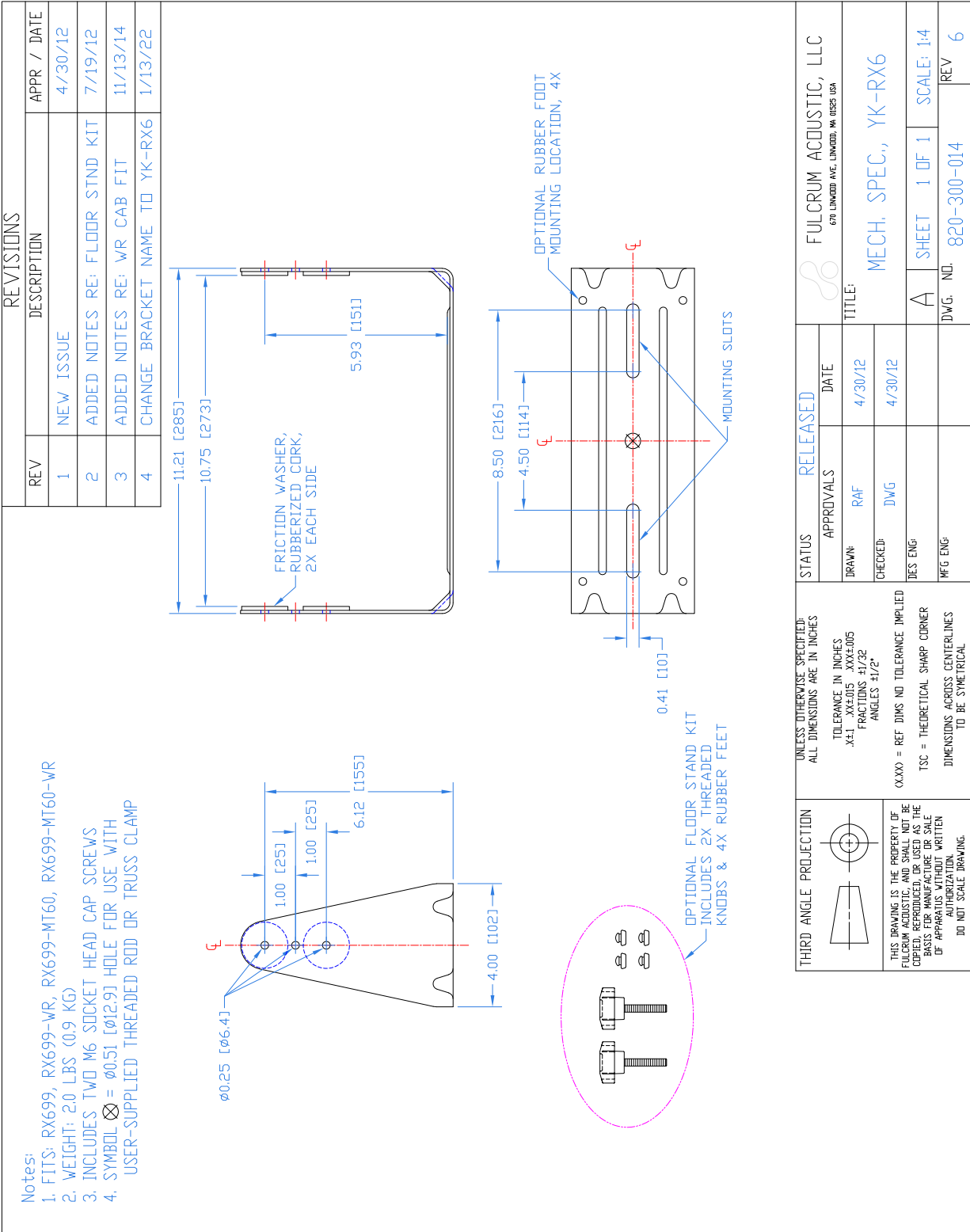

Drawing is reduced. Do not scale.