



M

Dual 12 inch Coaxial Loudspeaker

prophile[™]
SERIES



Overview

The Prophile M is a bi-amplified, 3-way coaxial loudspeaker that provides the output and pattern control of two 12 inch transducers in an enclosure size that would typically house a conventional 2-way system. The M's dedicated low frequency transducer was selected to provide maximum mid bass impact, and the coaxial driver's conical horn is ideal for the wide by wide coverage requirements of near field applications. The ultra-low profile, horizontally-oriented enclosure may be mounted close to ceilings, in front of balcony fascias, or along a stage front with minimal effect on sight lines.

Fulcrum Acoustic's **TQ™** processing is an integral part of the M design. Sound, innovative acoustical design combined with state of the art digital processing leads to exceptional clarity and precise transient response, even at very high sound pressure levels. The required digital signal processing can be provided by one of many supported platforms.

The M is an excellent option any time visceral impact and/or high SPL is needed from a package less than 40 centimeters tall. In addition, its coaxial design gives it the ability to provide a stable, high fidelity image at close range. This makes it the perfect choice for live reinforcement or dance club systems, high intensity DJ monitors, A/V screening rooms, high output fill systems, and more.

Performance Specifications¹

Operating Mode

Bi-amplified w/ DSP

Operating Range²

49 Hz to 20 kHz

Nominal Beamwidth

75° x 75°

Transducers

LF: 12.0" ceramic magnet woofer, 4.0" voice coil
HF/LF: Coaxial 3.0" titanium diaphragm compression driver;
12.0" woofer, 3.0" voice coil; single neodymium magnet

Power Handling @ Nominal Impedance³

LF: 75 V / 700 W @ 8 Ω
HF/LF: 57 V / 400 W @ 8 Ω

Nominal Sensitivity @ Input Voltage⁴ (whole space)

LF: 93 dB @ 2.83 V
HF/LF: 103 dB @ 2.83 V

Nominal Maximum SPL (peak / continuous)

LF: 127 dB / 121 dB
HF/LF: 135 dB / 129 dB

Equalized Sensitivity @ Input Voltage⁵

98 dB @ 2.83 V

Equalized Maximum SPL⁶ (peak / continuous)

134 dB / 128 dB

Recommended Power Amplifiers

LF: 700 W to 1400 W @ 8 Ω
HF/LF: 400 W to 800 W @ 8 Ω

Physical Specifications

Connections

(2) Neutrik NL4 Speakon
Pin 1+/-: LF
Pin 2+/-: HF/LF

Mounting / Suspension Points

(12) M10 eye bolt angle points, (2) M10 yoke points,
(1) M10 pull back point

Dimensions / Weight

See page 5

Finish

Black painted enclosure w/ gloss black grille, or
White painted enclosure w/ semi-gloss white grille

Options

M U Bracket [YK3013], Terminal strip input,
Custom color finish, Weather-resistant (WR) enclosure



product specification

Axial Sensitivity (dB SPL, 2.83 V @ 1 m)^{7,8}

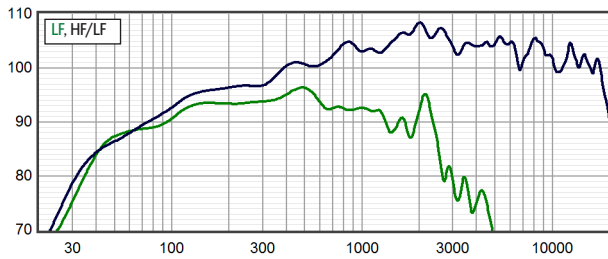

Horizontal Off Axis Response^{7,11}

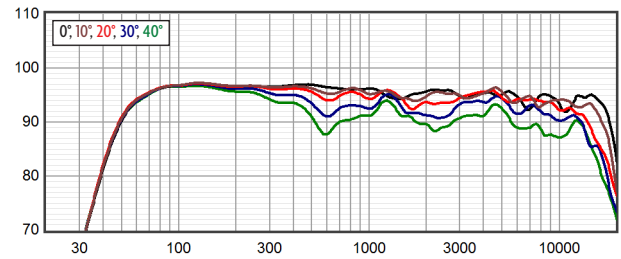

Axial Processed Response (dB)^{7,9}

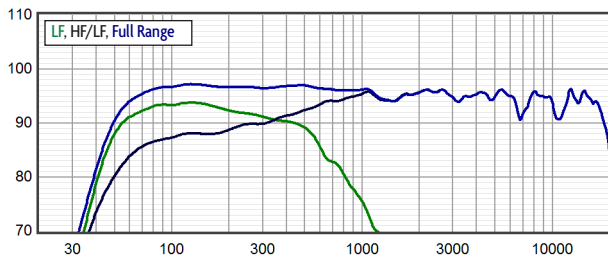

Vertical Off Axis Response^{7,11}

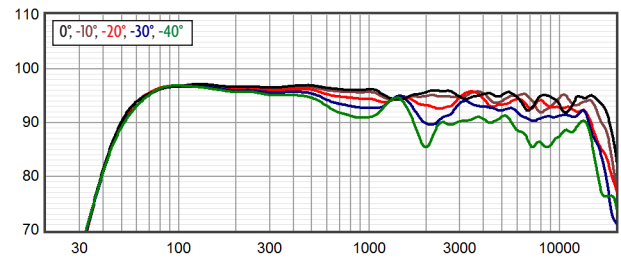

Axial Processed Phase Response (degrees)^{7,10}

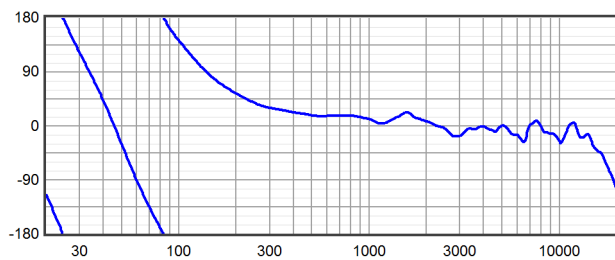

Beamwidth^{7,12}

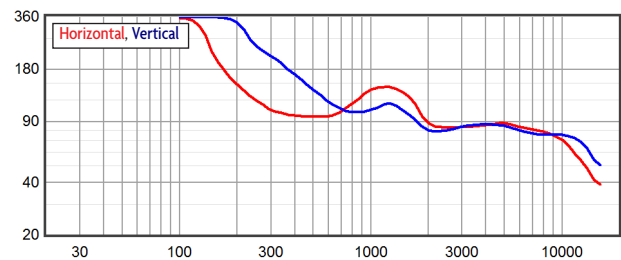

Impedance (ohms)

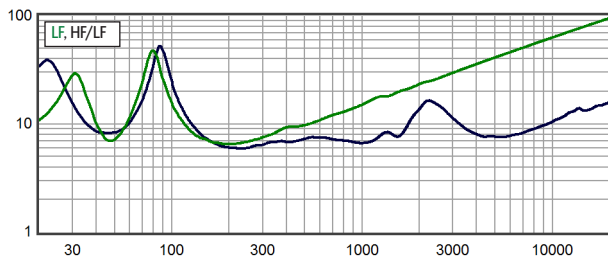

Directivity Index (dB)¹³

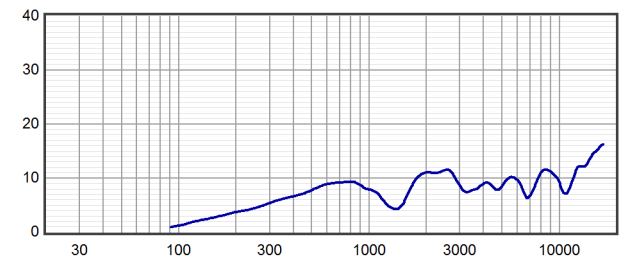



product specification

Horizontal Polar Response (30 dB Scale, 6 dB per Major Division)

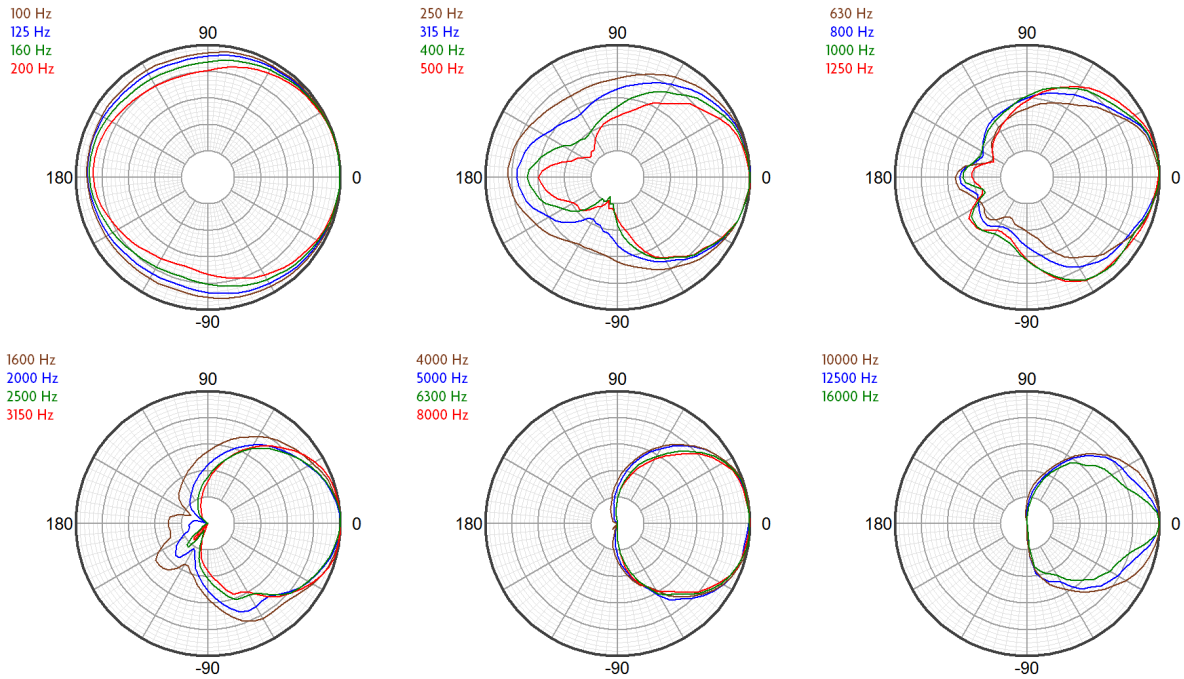

Vertical Polar Response (30 dB Scale, 6 dB per Major Division)

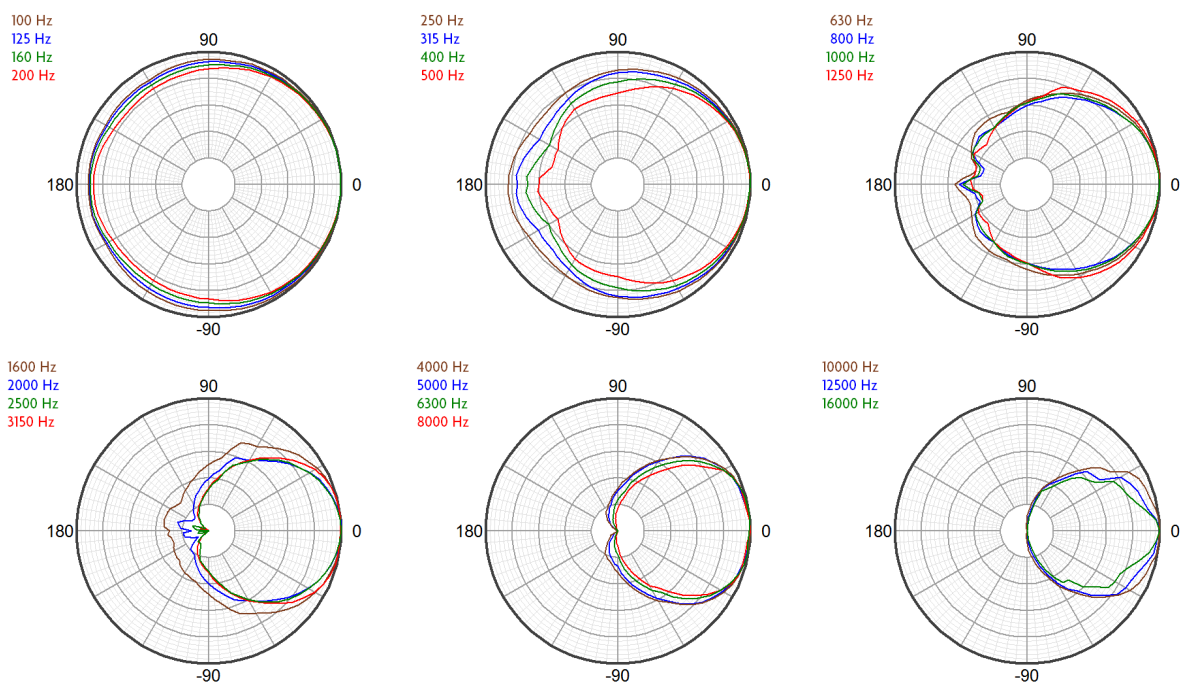



Technologies

The Prophile M represents a modern, digital-signal-processing-aware update to the traditional coaxial loudspeaker concept. The well-known benefits of the coaxial approach have been realized without the familiar shortcomings of historical designs. **Fulcrum Acoustic's Temporal Equalization™ (TQ™)** digital signal processing techniques eliminate midrange colorations and high frequency harshness while producing a smooth, seamless coverage pattern through the crossover range.

The M's coaxial transducer includes a 3 inch diaphragm compression driver. The large diaphragm area permits the compression driver to operate at frequencies too low for smaller compression drivers to handle and allows it to produce extreme sound pressure levels with an effortless sonic character. The coaxial woofer's large radiating surface works in conjunction with the conical HF horn to improve

directional control at the bottom of the horn's operating range, increasing directional control beyond what can be accomplished by the horn alone. The transducer's compact, neodymium magnet not only minimizes weight, but also allows very tight spacing between the compression driver and woofer voice coils. The delay between the driver outputs is thereby minimized, which allows the coaxial device to work well with a passive crossover.

Low frequency output and reliability are maximized with a uniquely effective alignment technique. A separate, dedicated, high-excursion LF transducer extends output capability below 100 Hz. Its operating range overlaps that of the coaxial device up to approximately 300 Hz. Drive levels are tailored so that the summed response is "flat"; yet the arrangement results in a 4 dB increase in overall low frequency output capability compared to a conventional 3-way system.

Connection Diagram

3-way, Bi-Amp

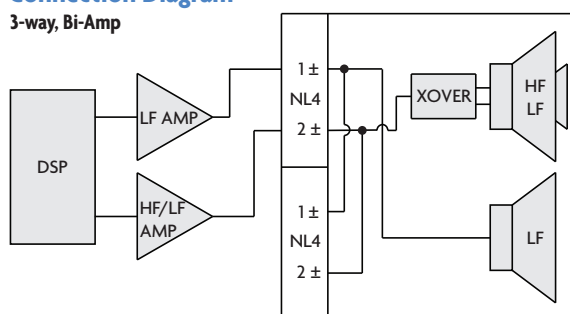

Mechanical Specification Drawings

2D and 3D DXF dimensional drawings are available for download at www.fulcrum-acoustic.com/support.

Notes

- ¹ **Performance Specifications** All acoustic specifications rounded to nearest whole number. External DSP with Fulcrum Acoustic-provided settings is required to achieve the specified performance.
- ² **Operating Range** The frequency range within which the processed response is within 10 dB of the average.
- ³ **Power Handling** Based on the AES power handling of the transducers.
- ⁴ **Nominal Sensitivity** The 1-meter-referenced SPL produced by a 1 watt band limited pink noise signal, with no processing applied.
- ⁵ **Equalized Sensitivity** The 1-meter-referenced SPL produced when an EIA-426-B signal is applied to an equalized loudspeaker system, at a level which produces a total power of 1 watt, in sum, to the loudspeaker subsections.
- ⁶ **Equalized Maximum SPL** The 1-meter-referenced SPL produced when an EIA-426-B signal is applied to an equalized loudspeaker system, at a level which drives at least one subsection to its rated power.
- ⁷ **Resolution** All response graphs are subjected to 1/6 octave cepstral smoothing with a gaussian weighting function.
- ⁸ **Axial Sensitivity** The SPL plotted against frequency for a 1 watt swept sine wave, referenced to 1 m with no signal processing.
- ⁹ **Axial Processed Response** The axial magnitude response with recommended signal processing applied.
- ¹⁰ **Axial Processed Phase Response** The axial phase response with recommended signal processing applied, and latency removed.
- ¹¹ **Horizontal / Vertical Off Axis Responses** The magnitude response at various angles off axis, with recommended signal processing applied.
- ¹² **Beamwidth** The angle between the -6 dB points in a loudspeaker's polar response.
- ¹³ **Directivity Index (Di)** The ratio of the on-axis sound pressure squared to the spherical average of the sound pressure squared at a particular frequency expressed in dB. To convert the directivity index to directivity factor (Q) use the formula $10^{Di/10}$.



product specification

Notes:

1. Net Weight = Approx. 76.0 lb / 34.5 kg
2. Ship Weight = Approx. 86.0 lb / 39.0 kg
3. Symbol ○ = M10 eye bolt angle point
4. Symbol ● = M10 nut plate
5. Symbol ⊕ = CoG

REVISIONS		
REV	DESCRIPTION	APPR / DATE
2	ADDED COG, UPDATED WEIGHT	RAF 6/11/09
3	CORRECTED REAR VIEW & DIM	RAF 8/28/09
4	DELETED 4X EB POINTS, MOVED 4X EB POINTS, CHANGED REAR M6 NUT PLATE TO M10	RAF 8/28/09
5	ADD SHIPPING WEIGHT	RAF 12/8/11

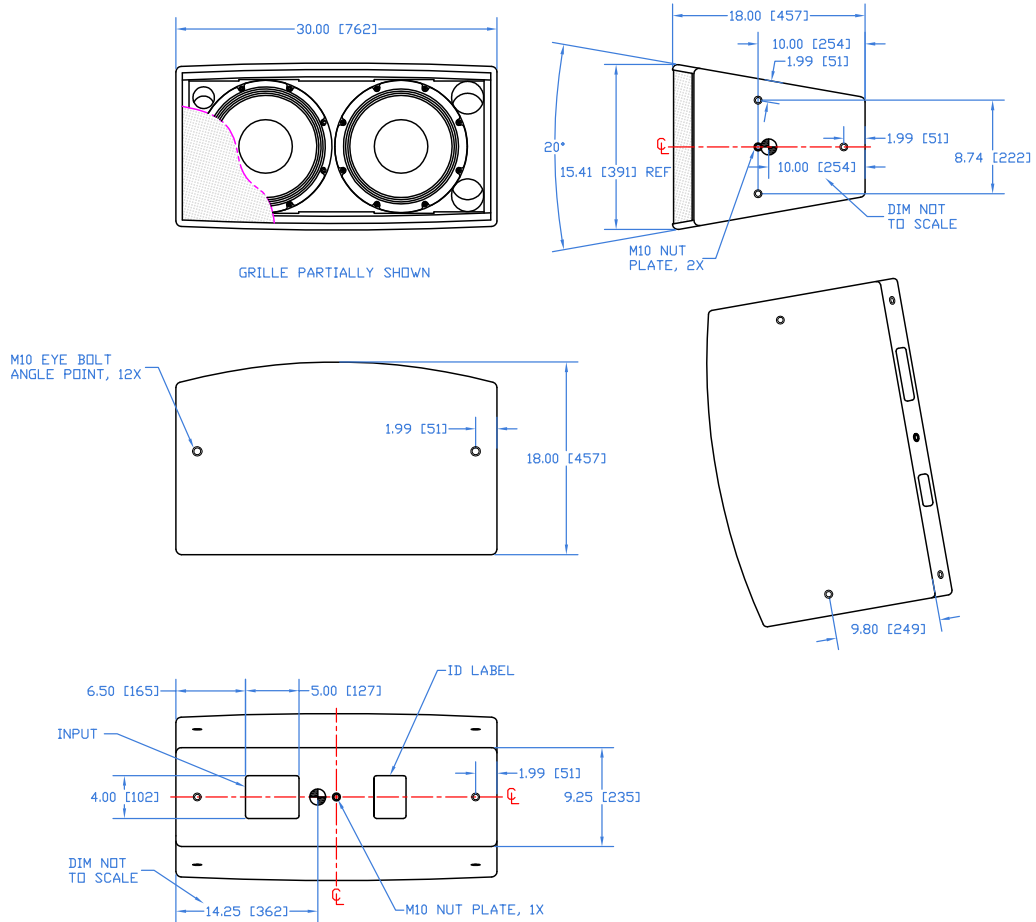

THIRD ANGLE PROJECTION

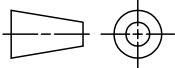

THIS DRAWING IS THE PROPERTY OF FULCRUM ACOUSTIC, AND SHALL NOT BE COPIED, REPRODUCED, OR USED AS THE BASIS FOR MANUFACTURE OR SALE OF APPARATUS WITHOUT WRITTEN AUTHORIZATION. DO NOT SCALE DRAWING.

UNLESS OTHERWISE SPECIFIED: ALL DIMENSIONS ARE IN INCHES

TOLERANCE IN INCHES
.X±.1 .XX±.015 .XXX±.005
FRACTIONS ±1/32
ANGLES ±1/2°

(X.XX) = REF DIMS NO TOLERANCE IMPLIED

TSC = THEORETICAL SHARP CORNER

DIMENSIONS ACROSS CENTERLINES TO BE SYMMETRICAL

STATUS RELEASED

APPROVALS	DATE
-----------	------

DRAWN: DWG	3/11/09
------------	---------

CHECKED: RAF	6/12/09
--------------	---------

DES ENG:	
----------	--

MFG ENG:	
----------	--



FULCRUM ACOUSTIC, LLC
670 LINWOOD AVE, LINWOOD, MA 01525 USA

TITLE:
Mechanical Spec, M

B	SHEET 1 OF 1	SCALE: 1:16
---	--------------	-------------

DWG. NO. 820-100-018	REV 5
----------------------	-------

Drawing is reduced. Do not scale.



product specification, weather-resistant (WR) version

Notes:

1. Net Weight = Approx. 97.0 lb / 44.0 kg
2. Ship Weight = Approx. 107.0 lb / 48.5 kg
3. Symbol = M10 eye bolt angle point
4. Symbol = M10 nut plate
5. Symbol = CoG
6. Exterior dimensions are based on fiberglass thickness of 0.125 inch. Actual thickness may vary by ±0.06 inches.

REVISIONS		
REV	DESCRIPTION	APPR / DATE
1	NEW ISSUE	RAF 1/21/16

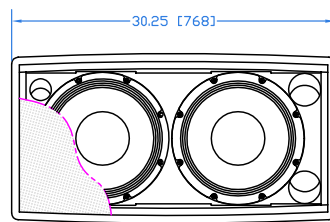

GRILLE PARTIALLY SHOWN

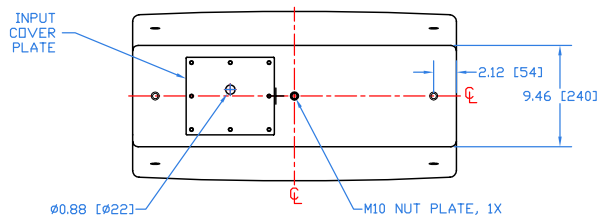
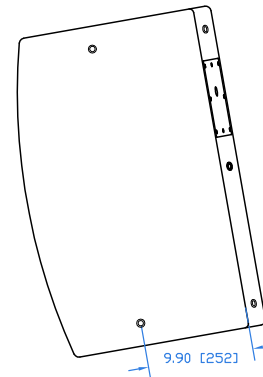
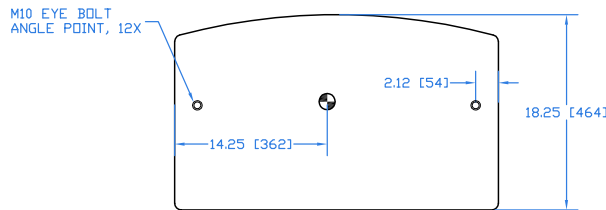
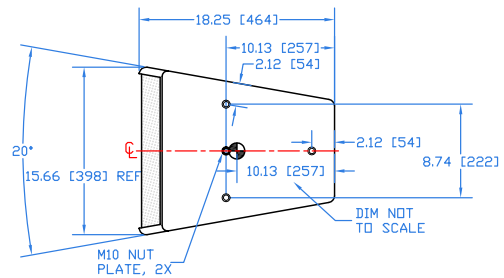

THIRD ANGLE PROJECTION

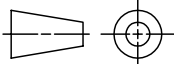

THIS DRAWING IS THE PROPERTY OF FULCRUM ACOUSTIC, AND SHALL NOT BE COPIED, REPRODUCED, OR USED AS THE BASIS FOR MANUFACTURE OR SALE OF APPARATUS WITHOUT WRITTEN AUTHORIZATION. DO NOT SCALE DRAWING.

UNLESS OTHERWISE SPECIFIED, ALL DIMENSIONS ARE IN INCHES

TOLERANCE IN INCHES
.XX±.015 .XXX±.005
FRACTIONS ±1/32
ANGLES ±1/2°

(X.XX) = REF DIMS NO TOLERANCE IMPLIED

TSC = THEORETICAL SHARP CORNER

DIMENSIONS ACROSS CENTERLINES TO BE SYMMETRICAL

STATUS RELEASED

APPROVALS	DATE
DRAWN: RAF	1/21/16
CHECKED: DWG	1/21/16
DES ENG:	
MFG ENG:	



FULCRUM ACOUSTIC, LLC
670 LINWOOD AVE, LINWOOD, MA 01525 USA

TITLE:
Mechanical Spec, M-WR

B SHEET 1 OF 1 SCALE: 1:16

DWG. NO. 820-100-095 REV 1

Drawing is reduced. Do not scale.

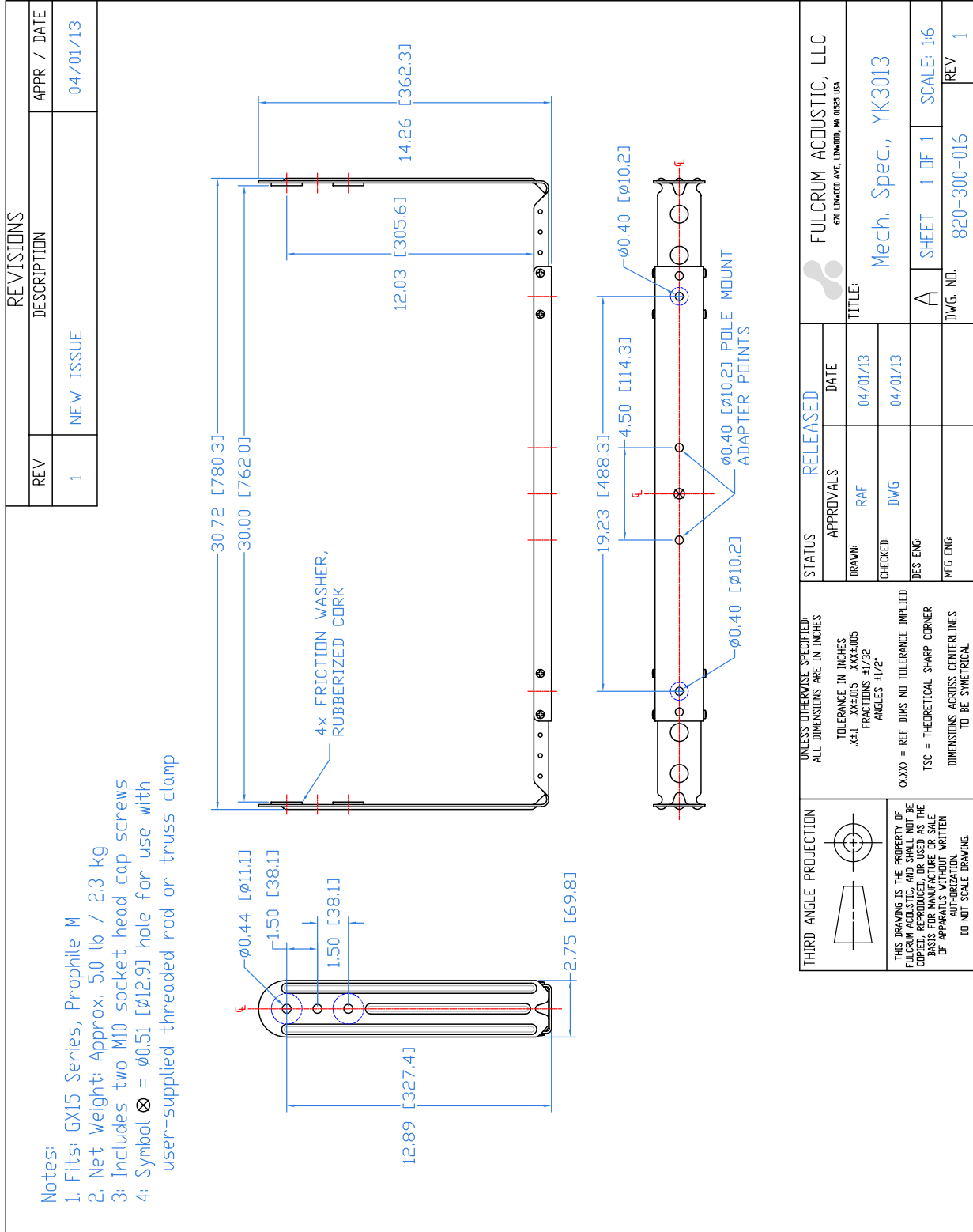

Drawing is reduced. Do not scale.