



product specification

S

Dual 8 inch Coaxial Loudspeaker

prophile[™]
SERIES



Overview

The Prophile™ S coaxial loudspeaker provides the output capability of a dual 8 inch loudspeaker in an enclosure size typically associated with a single 8 inch, 2-way system. The S's coaxial driver gives it the ability to provide a stable, high fidelity image at close range, and its dedicated low frequency transducer provides additional mid bass impact. Its horizontal orientation, small vertical dimension, and trapezoidal shape allow it to be positioned extremely close to ceilings and under balconies. The S's low profile also makes it very useful as a front fill system when placed on the edge of or installed into a stage apron.

Fulcrum Acoustic's **TQ™** processing is an integral part of the S design. Sound, innovative acoustical design combined with state of the art digital processing leads to exceptional clarity and precise transient response, even at very high sound pressure levels. The required digital signal processing can be provided by one of many supported platforms.

The S is an excellent option any time limited space is available. Its high efficiency results in impressive levels, and its 100° x 100° coverage and coaxial design make it especially effective in close quarters. Low frequency extension to 80 Hz allows the S to provide impressive impact and enables it to integrate well with subwoofers. This makes it an ideal choice for small live reinforcement or dance club systems, high intensity DJ monitors, A/V screening rooms, high output fill systems, and more.

Performance Specifications¹

Operating Mode

Single-amplified w/ DSP

Operating Range²

80 Hz to 20 kHz

Nominal Beamwidth

100° x 100°

Transducers

LF: 8.0" ceramic magnet woofer, 2.0" voice coil
HF/LF: Coaxial 1.7" titanium diaphragm compression driver;
8.0" woofer, 2.0" voice coil; single neodymium magnet

Power Handling @ Nominal Impedance³

63 V / 500 W @ 8 Ω

Nominal Sensitivity @ Input Voltage⁴ (whole space)

98 dB @ 2.83 V

Nominal Maximum SPL (peak / continuous)

131 dB / 125 dB

Equalized Sensitivity @ Input Voltage⁵

96 dB @ 2.83 V

Equalized Maximum SPL⁶ (peak / continuous)

129 dB / 123 dB

Recommended Power Amplifier

500 W to 1000 W @ 8 Ω

Physical Specifications

Connections

(2) Neutrik NL4 Speakon

Pin 1+/-: Full Range

Pin 2+/-: NC

Mounting / Suspension Points

(8) M6 eye bolt angle points, (2) M6 yoke points,

(1) M6 pull back point

Dimensions / Weight

See page 5

Finish

Black painted enclosure w/ matte black grille, or

White painted enclosure w/ matte white grille

Options

S U Bracket [YK1808], Terminal strip input,

Custom color finish, Weather-resistant (WR) enclosure



Axial Sensitivity (dB SPL, 2.83 V @ 1 m)^{7,8}

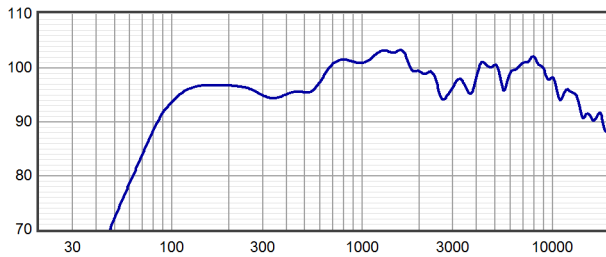

Horizontal Off Axis Response^{7,11}

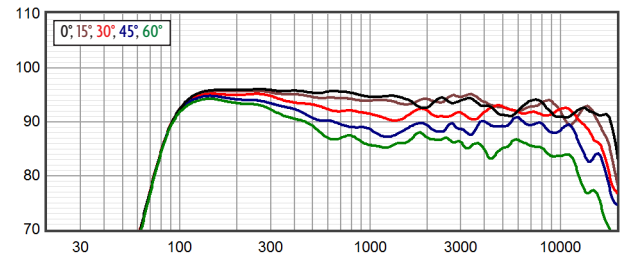

Axial Processed Response (dB)^{7,9}

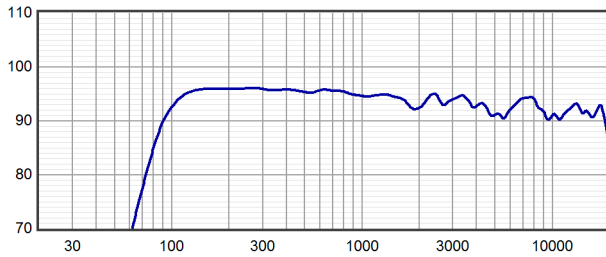

Vertical Off Axis Response^{7,11}

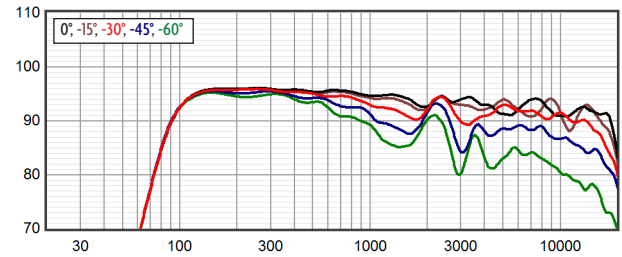

Axial Processed Phase Response (degrees)^{7,10}

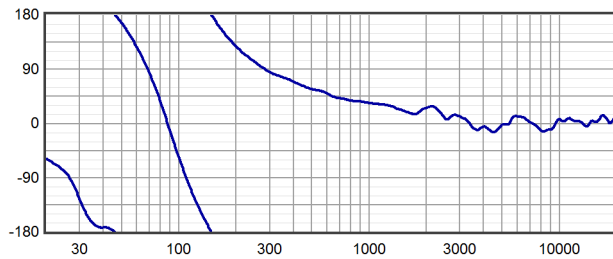

Beamwidth^{7,12}

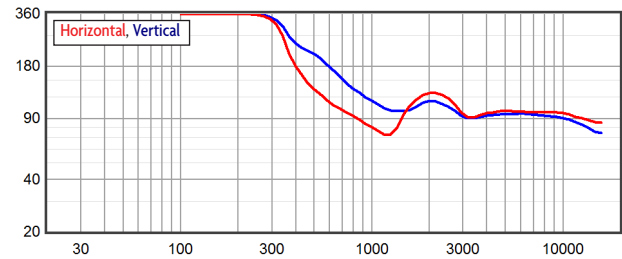

Impedance (ohms)

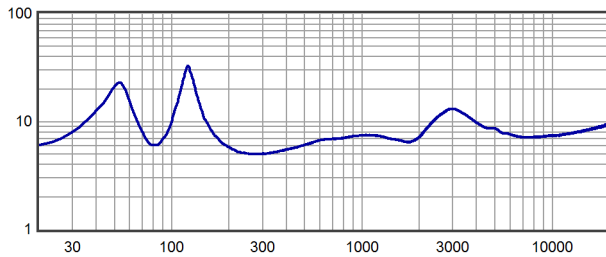

Directivity Index (dB)¹³

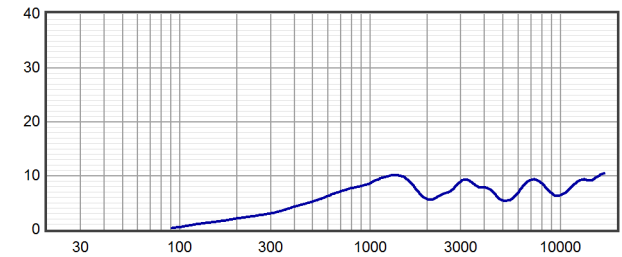



product specification

Horizontal Polar Response (30 dB Scale, 6 dB per Major Division)

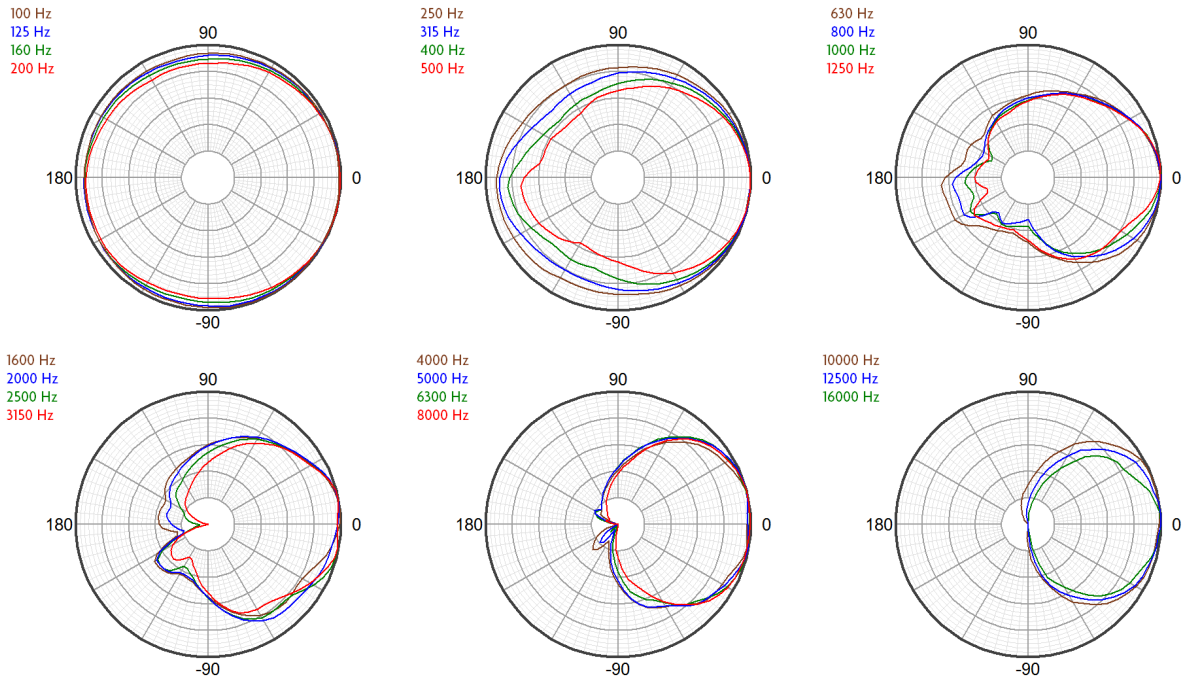

Vertical Polar Response (30 dB Scale, 6 dB per Major Division)

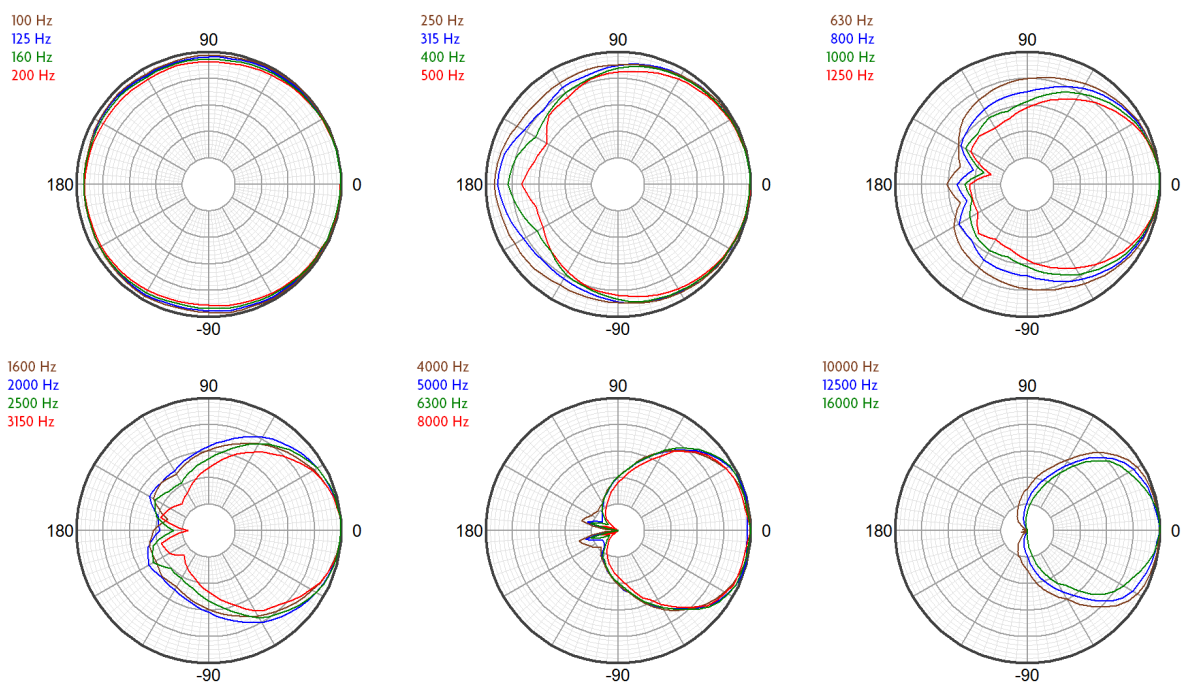



Technologies

The Prophile S includes a neodymium based coaxial driver, which allows the compression driver diaphragm to be positioned very close to the woofer voice coil. This allows the system to maintain coherent summation and consistent off axis response through a 3-way passive crossover, allowing it to be driven with a single amplifier channel.

The two low frequency devices both operate down to the lowest frequencies, resulting in mutual coupling that provides unusually high efficiency and impact in the critical 80 Hz to 500 Hz range.

Connection Diagram

3-way, Single-Amp

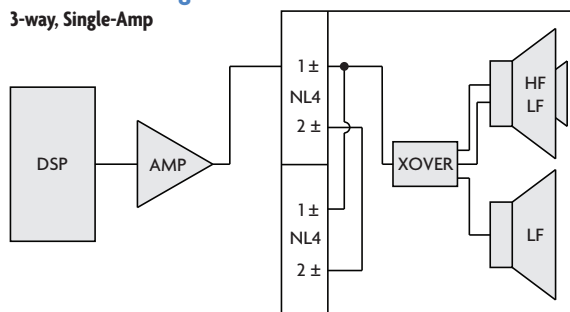

Mechanical Specification Drawings

2D and 3D DXF dimensional drawings are available for download at www.fulcrum-acoustic.com/support.

Notes

¹ **Performance Specifications** All acoustic specifications rounded to nearest whole number. External DSP with Fulcrum Acoustic-provided settings is required to achieve the specified performance.

² **Operating Range** The frequency range within which the processed response is within 10 dB of the average.

³ **Power Handling** Based on the AES power handling of the transducers.

⁴ **Nominal Sensitivity** The 1-meter-referenced SPL produced by a 1 watt band limited pink noise signal, with no processing applied.

⁵ **Equalized Sensitivity** The 1-meter-referenced SPL produced when an EIA-426-B signal is applied to an equalized loudspeaker system, at a level which produces a total power of 1 watt, in sum, to the loudspeaker subsections.

⁶ **Equalized Maximum SPL** The 1-meter-referenced SPL produced when an EIA-426-B signal is applied to an equalized loudspeaker system, at a level which drives at least one subsection to its rated power.

⁷ **Resolution** All response graphs are subjected to 1/6 octave cepstral smoothing with a gaussian weighting function.

⁸ **Axial Sensitivity** The SPL plotted against frequency for a 1 watt swept sine wave, referenced to 1 m with no signal processing.

⁹ **Axial Processed Response** The axial magnitude response with recommended signal processing applied.

¹⁰ **Axial Processed Phase Response** The axial phase response with recommended signal processing applied, and latency removed.

¹¹ **Horizontal / Vertical Off Axis Responses** The magnitude response at various angles off axis, with recommended signal processing applied.



¹² **Beamwidth** The angle between the -6 dB points in a loudspeaker's polar response.

¹³ **Directivity Index (Di)** The ratio of the on-axis sound pressure squared to the spherical average of the sound pressure squared at a particular frequency expressed in dB. To convert the directivity index to directivity factor (Q) use the formula $10^{Di/10}$.



product specification

Notes:

1. Net Weight = Approx. 34.0 lb / 15.4 kg
2. Ship Weight = Approx. 39.0 lb / 17.7 kg
3. Symbol  = M6 eye bolt angle point
4. Symbol  = M6 nut plate
5. Symbol  = CoG

REVISIONS		
REV	DESCRIPTION	APPR / DATE
3	REDESIGN ENCLOSURE TO MATCH OTHER PROFILE SERIES LOUDSPEAKERS	RAF 5/25/10
4	CORRECT REAR HEIGHT DIMENSION	RAF 6/14/10
5	ADD SHIPPING WEIGHT	RAF 6/14/10
6	OMNIMOUNT TO 'THIRD PARTY' IN NOTE 5	RAF 1/13/12
7	REMOVE PAN/TILT MOUNT POINTS	RAF 7/28/16

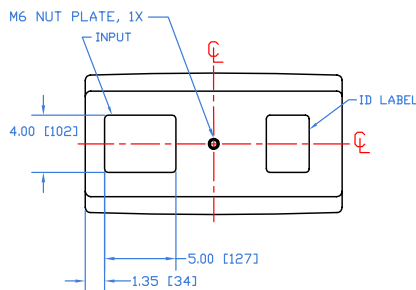
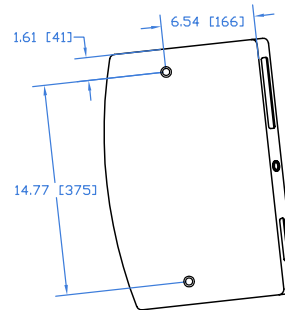
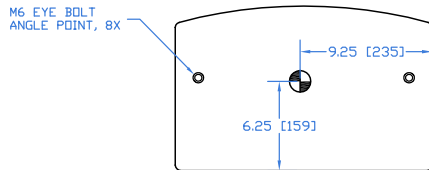
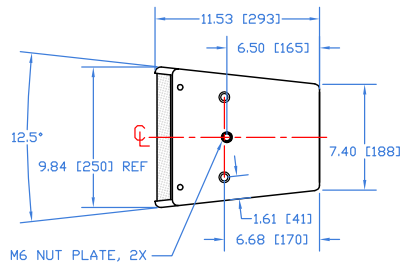
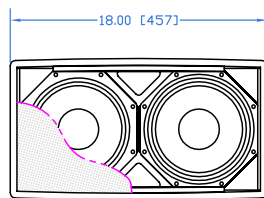

THIRD ANGLE PROJECTION

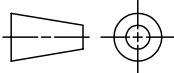

THIS DRAWING IS THE PROPERTY OF FULCRUM ACOUSTIC, AND SHALL NOT BE COPIED, REPRODUCED, OR USED AS THE BASIS FOR MANUFACTURE OR SALE OF APPARATUS WITHOUT WRITTEN AUTHORIZATION. DO NOT SCALE DRAWING.

UNLESS OTHERWISE SPECIFIED: ALL DIMENSIONS ARE IN INCHES

TOLERANCE IN INCHES
.X±.1 .XX±.015 .XXX±.005
FRACTIONS ±1/32
ANGLES ±1/2°

(X.XX) = REF DIMS NO TOLERANCE IMPLIED

TSC = THEORETICAL SHARP CORNER

DIMENSIONS ACROSS CENTERLINES TO BE SYMMETRICAL

STATUS PRODUCTION

APPROVALS	DATE
DRAWN: DWG	4/29/09
CHECKED: RAF	1/08/10
DES ENG:	
MFG ENG:	



FULCRUM ACOUSTIC, LLC
670 LINWOOD AVE, LINWOOD, MA 01525 USA

TITLE:
Mechanical Spec, S

B SHEET 1 OF 1 SCALE: 1:12

DWG. NO. 820-100-020 REV 7

Drawing is reduced. Do not scale.



product specification, weather-resistant (WR) version

Notes:

1. Net Weight = Approx. 34.0 lb / 15.4 kg
2. Ship Weight = Approx. 39.0 lb / 17.7 kg
3. Symbol = M6 eye bolt angle point
4. Symbol = M6 nut plate
5. Symbol = CoG

REV	DESCRIPTION	APPR / DATE
1	WR VERSION OF PROPHILE S	DWG 7/23/11
2	GENERAL DRAWING UPDATES	RAF 1/14/16
3	REMOVE PAN/TILT MOUNT POINTS	RAF 7/28/16

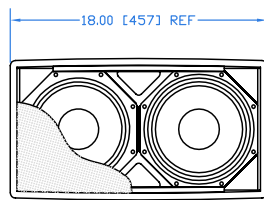

GRILLE PARTIALLY SHOWN

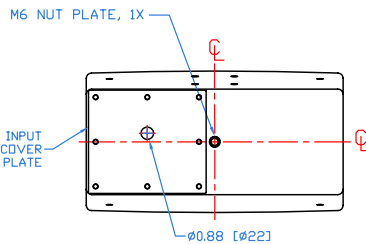
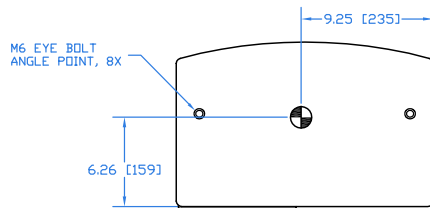
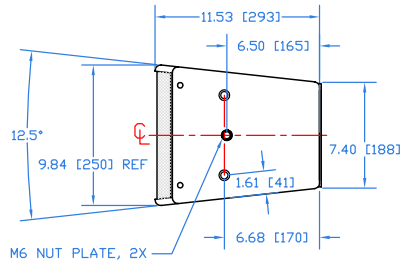

THIRD ANGLE PROJECTION

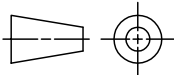

THIS DRAWING IS THE PROPERTY OF FULCRUM ACOUSTIC, AND SHALL NOT BE COPIED, REPRODUCED, OR USED AS THE BASIS FOR MANUFACTURE OR SALE OF APPARATUS WITHOUT WRITTEN AUTHORIZATION. DO NOT SCALE DRAWING.

UNLESS OTHERWISE SPECIFIED, ALL DIMENSIONS ARE IN INCHES

TOLERANCE IN INCHES
.XX±.015 .XXX±.005
FRACTIONS ±1/32
ANGLES ±1/2°

(X.XX) = REF DIMS NO TOLERANCE IMPLIED

TSC = THEORETICAL SHARP CORNER

DIMENSIONS ACROSS CENTERLINES TO BE SYMMETRICAL

STATUS PRODUCTION

APPROVALS DATE

DRAWN: DWG 7/23/11

CHECKED:

DES ENG:

MFG ENG:



FULCRUM ACOUSTIC, LLC
670 LINWOOD AVE, LINWOOD, MA 01525 USA

TITLE:
Mechanical Spec, S-WR

B SHEET 1 OF 1 SCALE: 1:12

DWG. NO. 820-100-049 REV 3

Drawing is reduced. Do not scale.

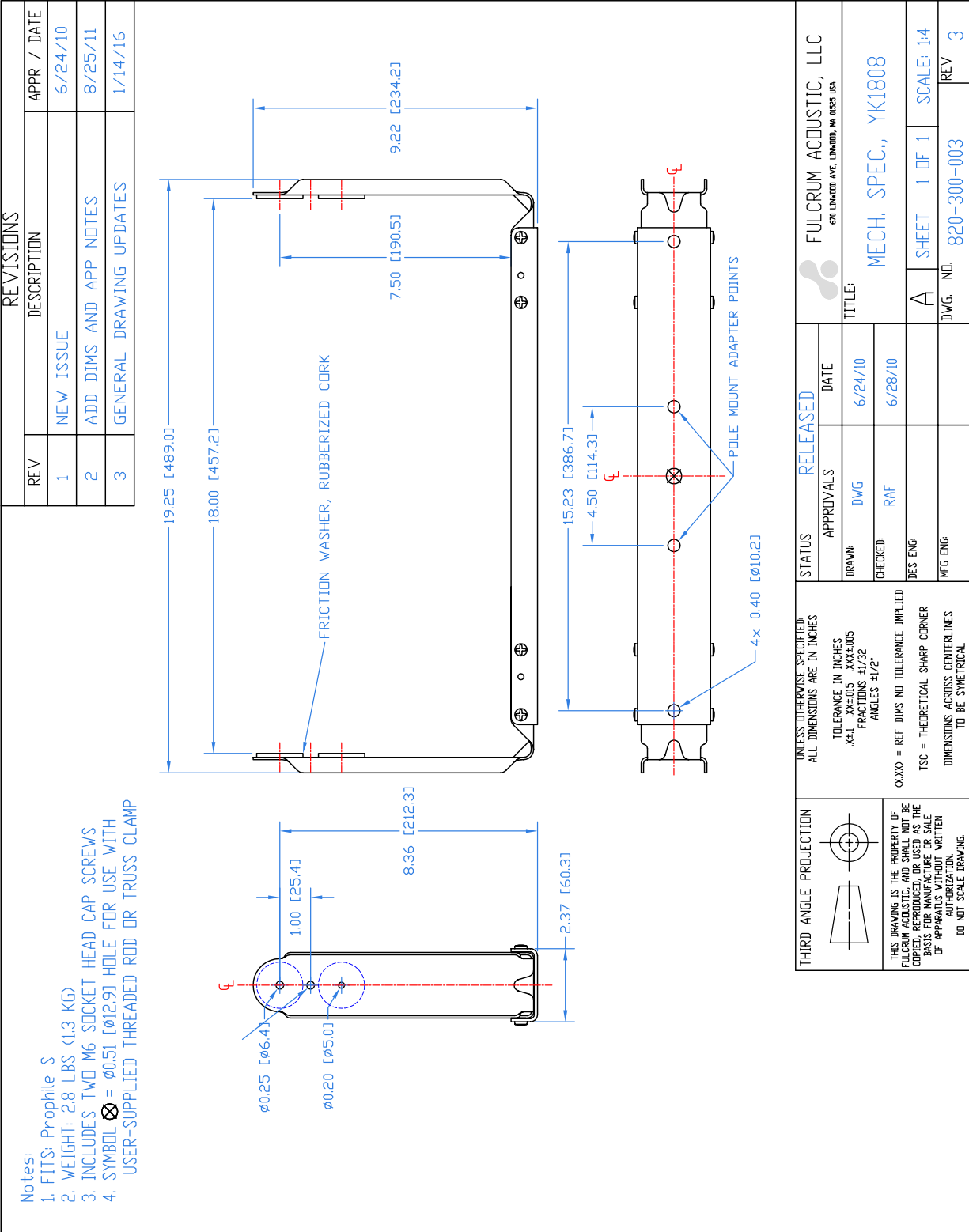

Drawing is reduced. Do not scale.