



fulcrum
ACOUSTIC®

product specification

GX1577

15 inch Coaxial Loudspeaker

tq^{install}
SERIES™



Overview

The GX1577 is a coaxial loudspeaker that provides the output capability and pattern control of a conventional premium 2-way system, but with the directional consistency and crisp transient response that only a coaxial transducer can provide. Its single-ceramic-magnet coaxial transducer and 75° x 75° horn provides effective coverage in situations where traditional 45° and 60° vertical patterns are too narrow. Its coverage pattern is particularly effective from an elevated position, and the compact enclosure's 40° trapezoidal angle allows it to be mounted near walls or ceilings with minimal effect on sight lines.

Fulcrum Acoustic's TQ™ processing is an integral part of the GX1577 design. Sound, innovative acoustical design combined with state of the art digital processing leads to exceptional clarity and precise transient response, even at very high sound pressure levels. The required digital signal processing can be provided by one of many supported platforms.

The GX1577 is particularly effective in systems where targeted pattern control is desirable, and is an excellent solution for high fidelity, foreground distributed systems. Its neat appearance and familiar format facilitates acceptance by interior designers and architects. This makes it the perfect choice for houses of worship, theaters, restaurants, transportation facilities, theme parks, and more.

Performance Specifications¹

Operating Mode

Single-amplified w/ DSP

Operating Range²

43 Hz to 19 kHz

Nominal Beamwidth

75° x 75°

Transducers

HF/LF: Coaxial 3.0" titanium diaphragm compression driver; 15.0" woofer, 3.0" voice coil; single ceramic magnet

Power Handling @ Nominal Impedance³

57 V / 400 W @ 8 Ω

Nominal Sensitivity @ Input Voltage⁴ (whole space)

101 dB @ 2.83 V

Nominal Maximum SPL (peak / continuous)

133 dB / 127 dB

Equalized Sensitivity @ Input Voltage⁵

97 dB @ 2.83 V

Equalized Maximum SPL⁶ (peak / continuous)

129 dB / 123 dB

Recommended Power Amplifier

400 W to 800 W @ 8 Ω

Physical Specifications

Connections

(2) Neutrik NL4 Speakon

Pin 1+/-: Full Range

Pin 2+/-: NC

Mounting / Suspension Points

(12) M10 eye bolt angle points, (2) M10 yoke points, or

(1) M10 pull back point

Dimensions / Weight

See page 5

Finish

Black painted enclosure w/ matte black grille, or

White painted enclosure w/ matte white grille

Options

GX15 Series U Bracket [YK3013], Terminal strip input, Custom color finish, Weather-resistant (WR) enclosure



Axial Sensitivity (dB SPL, 2.83 V @ 1 m)^{7,8}

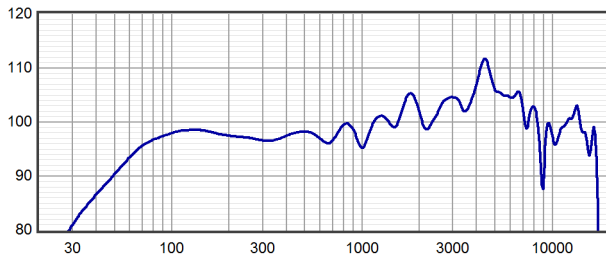

Horizontal Off Axis Response^{7,11}

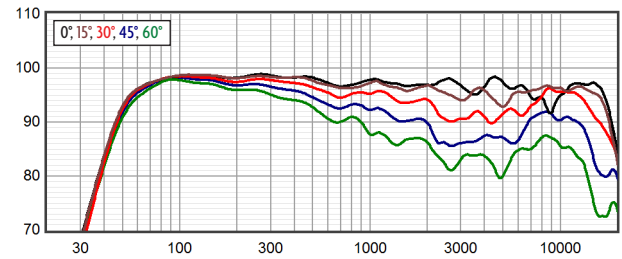

Axial Processed Response (dB)^{7,9}

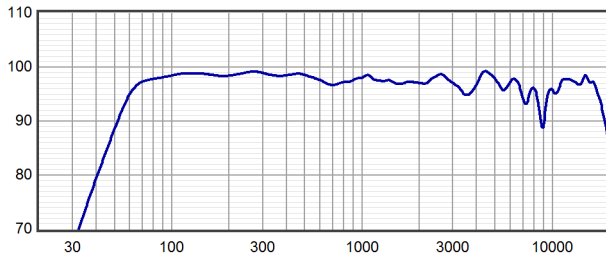

Vertical Off Axis Response^{7,11}

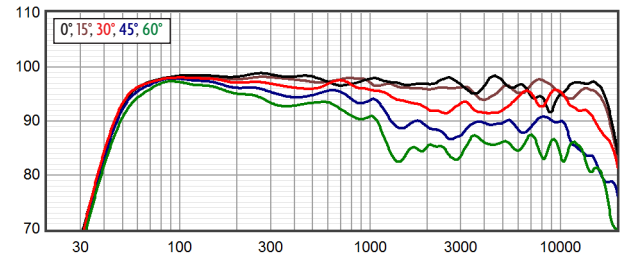

Axial Processed Phase Response (degrees)^{7,10}

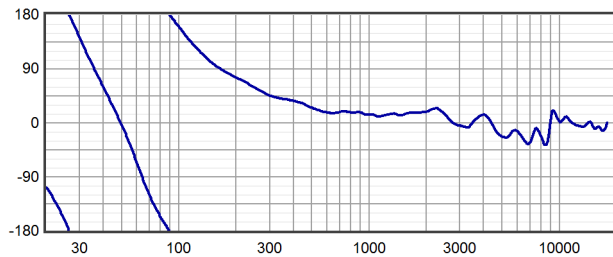

Beamwidth^{7,12}

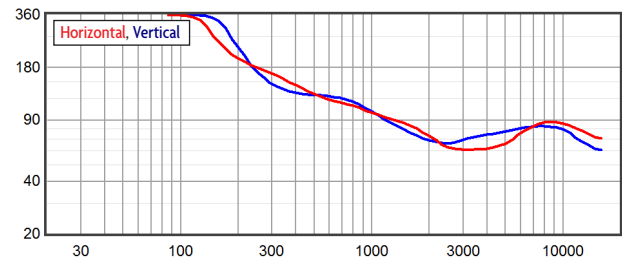

Impedance (ohms)

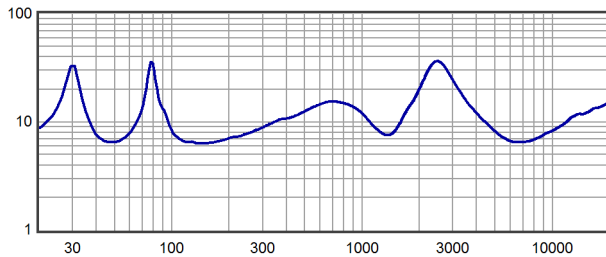

Directivity Index (dB)¹³

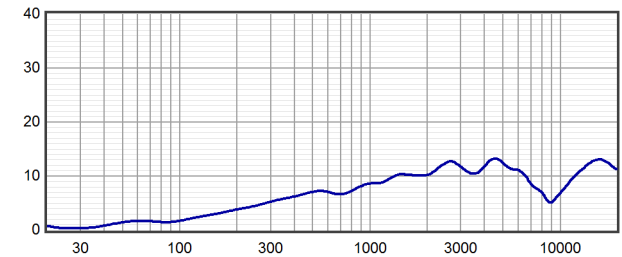



product specification

Horizontal Polar Response (30 dB Scale, 6 dB per Major Division)

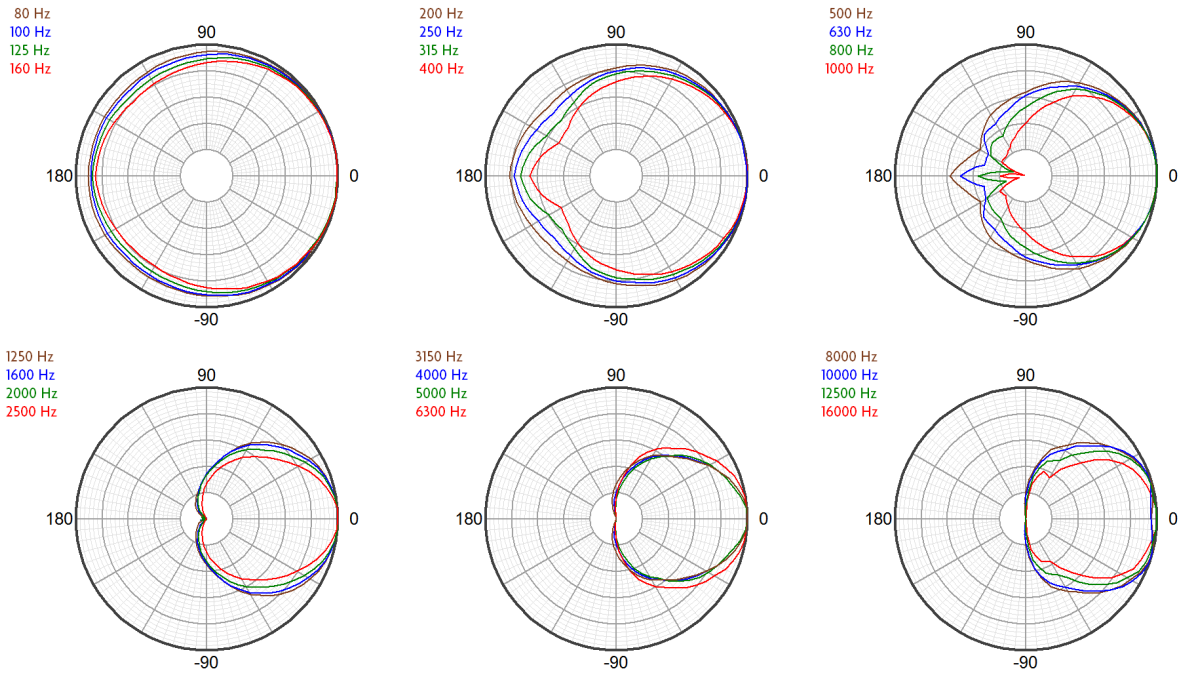

Vertical Polar Response (30 dB Scale, 6 dB per Major Division)

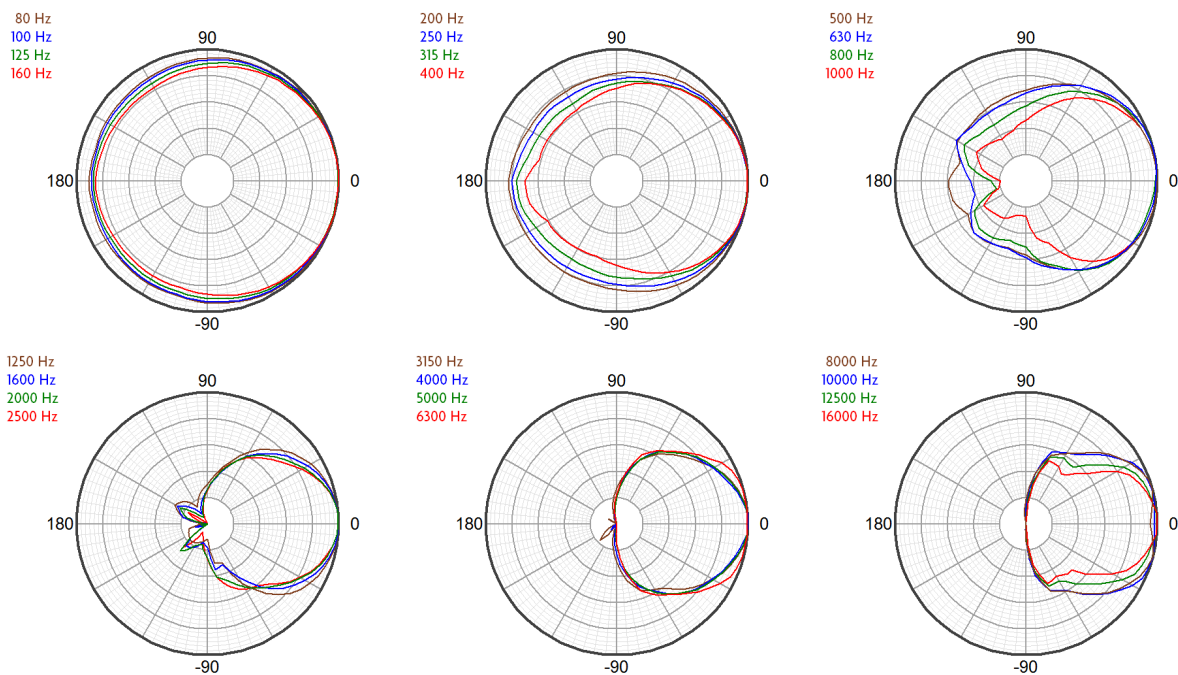



Technologies

The proprietary horns employed in the GX Series represent a modern digital-signal-processing-aware update to the traditional horn-loaded coaxial loudspeaker concept. The well-known benefits of the coaxial approach have been realized without the familiar shortcomings of historical designs. Fulcrum Acoustic's **Temporal Equalization™ (TQ™)** digital signal processing techniques eliminate midrange colorations and high frequency harshness while producing a smooth, seamless coverage pattern through the crossover range. In fact, the coaxial transducers were designed from the ground up to take advantage of the unique capabilities of TQ™.

The coaxial transducer in the GX1577 includes a 3 inch diaphragm compression driver. The large diaphragm area permits the compression driver to operate at frequencies too low for smaller

compression drivers to handle. This allows the high frequency horn to smooth the polar response of the low frequency section in the frequency range where the horn would otherwise cause shadowing. It also allows the compression driver to produce extreme sound pressure levels with an effortless sonic character.

The coaxial woofer's large radiating surface works in conjunction with the HF horn to improve directional control at the bottom of the horn's operating range, increasing directional control beyond what can be accomplished by the horn alone. The coaxial transducer's single-ceramic-magnet, dual-gap geometry not only minimizes cost and weight; it also allows very tight spacing between the compression driver and woofer voice coils. The delay between the driver outputs is thereby minimized, which allows the coaxial device to work well with a passive crossover.

Connection Diagram

2-way, Single-Amp

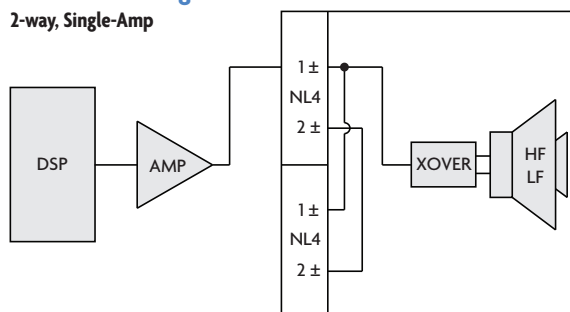

Mechanical Specification Drawings

2D and 3D DXF dimensional drawings are available for download at www.fulcrum-acoustic.com/support.

Notes

- ¹ **Performance Specifications** All acoustic specifications rounded to nearest whole number. External DSP with Fulcrum Acoustic-provided settings is required to achieve the specified performance.
- ² **Operating Range** The frequency range within which the processed response is within 10 dB of the average.
- ³ **Power Handling** Based on the AES power handling of the transducers.
- ⁴ **Nominal Sensitivity** The 1-meter-referenced SPL produced by a 1 watt band limited pink noise signal, with no processing applied.
- ⁵ **Equalized Sensitivity** The 1-meter-referenced SPL produced when an EIA-426-B signal is applied to an equalized loudspeaker system, at a level which produces a total power of 1 watt, in sum, to the loudspeaker subsections.
- ⁶ **Equalized Maximum SPL** The 1-meter-referenced SPL produced when an EIA-426-B signal is applied to an equalized loudspeaker system, at a level which drives at least one subsection to its rated power.
- ⁷ **Resolution** All response graphs are subjected to 1/6 octave cepstral smoothing with a gaussian weighting function.
- ⁸ **Axial Sensitivity** The SPL plotted against frequency for a 1 watt swept sine wave, referenced to 1 m with no signal processing.
- ⁹ **Axial Processed Response** The axial magnitude response with recommended signal processing applied.
- ¹⁰ **Axial Processed Phase Response** The axial phase response with recommended signal processing applied, and latency removed.
- ¹¹ **Horizontal / Vertical Off Axis Responses** The magnitude response at various angles off axis, with recommended signal processing applied.
- ¹² **Beamwidth** The angle between the -6 dB points in a loudspeaker's polar response.
- ¹³ **Directivity Index (Di)** The ratio of the on-axis sound pressure squared to the spherical average of the sound pressure squared at a particular frequency expressed in dB. To convert the directivity index to directivity factor (Q) use the formula $10^{Di/10}$.



product specification

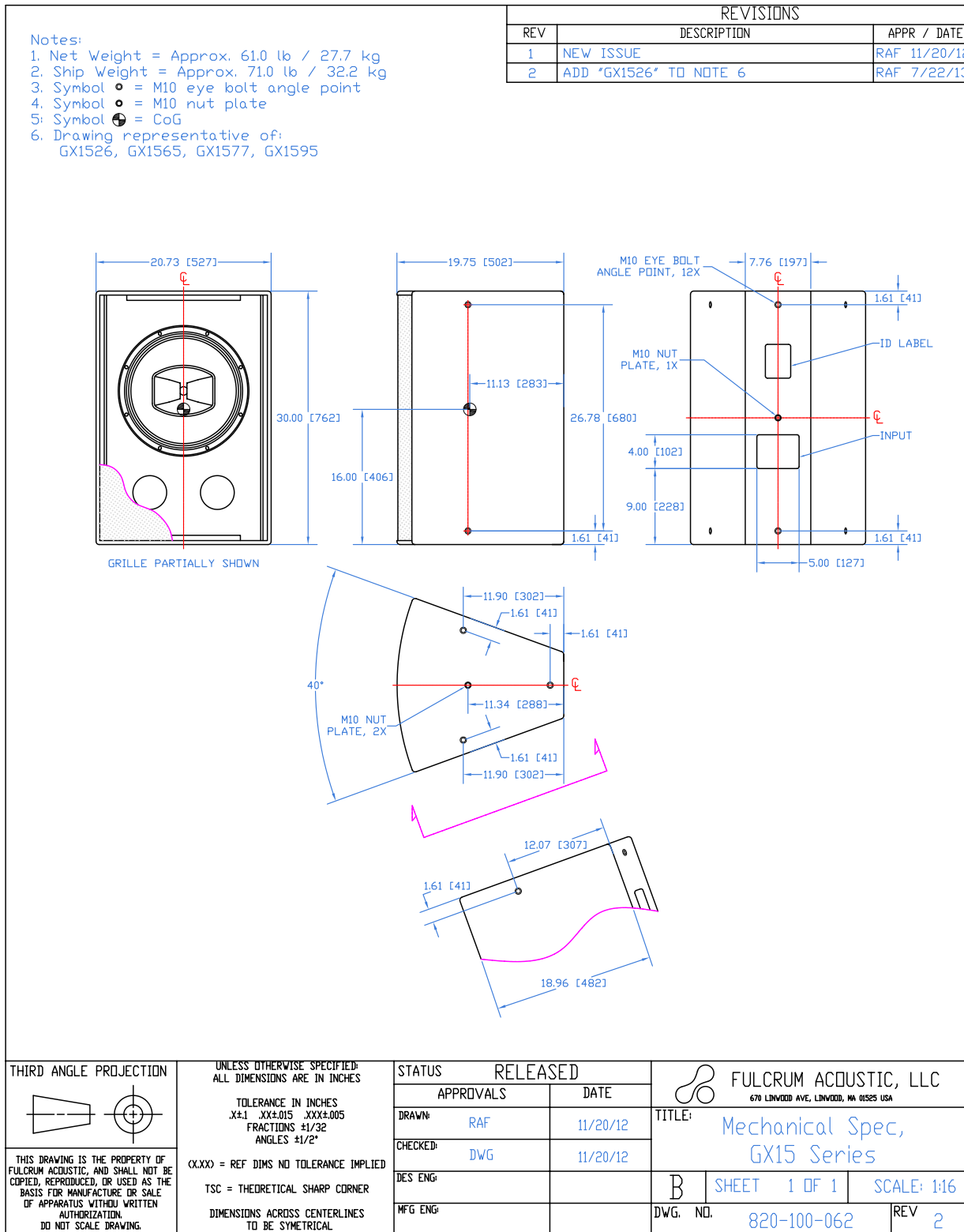

Drawing is reduced. Do not scale.



product specification, weather-resistant (WR) version

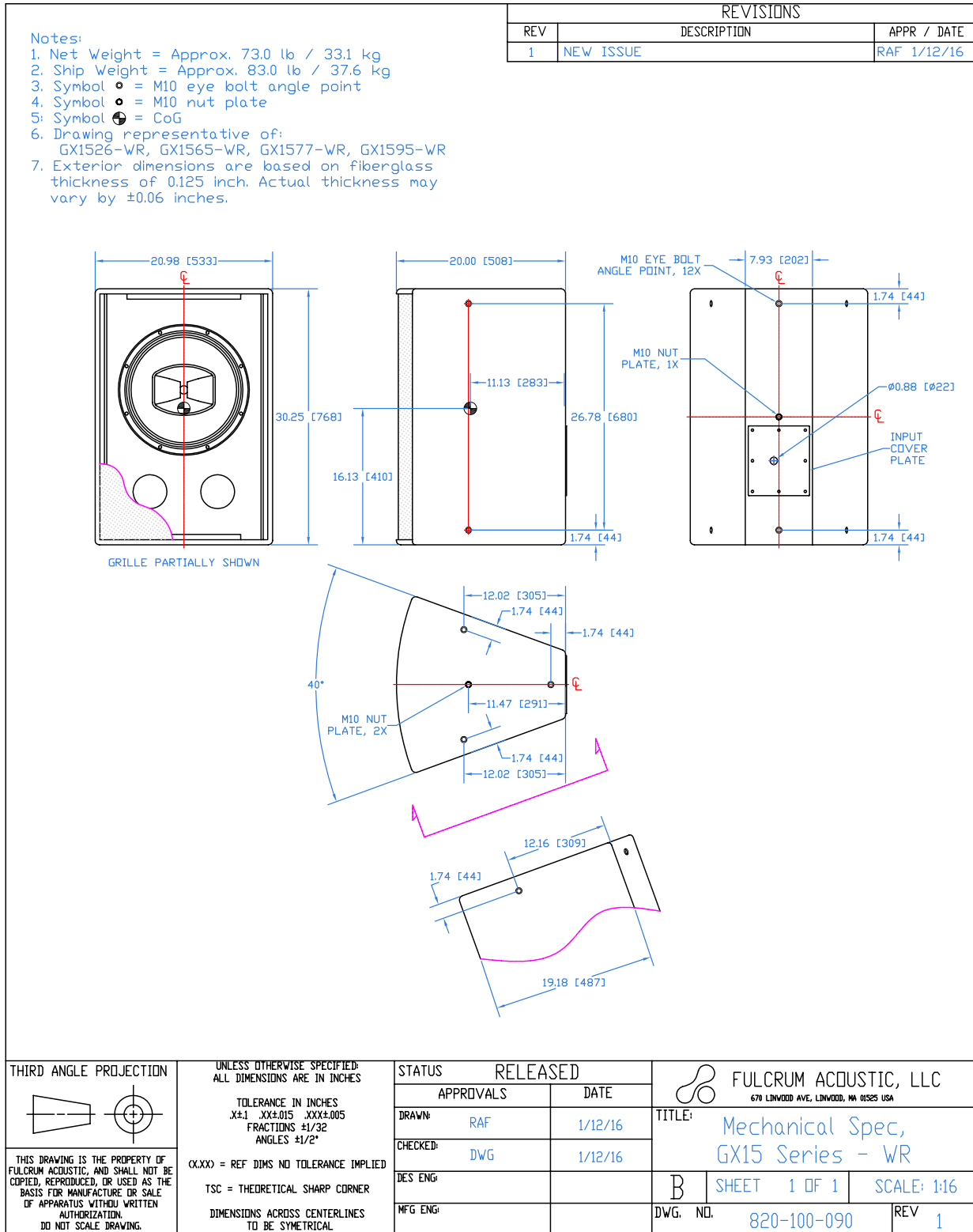

Drawing is reduced. Do not scale.

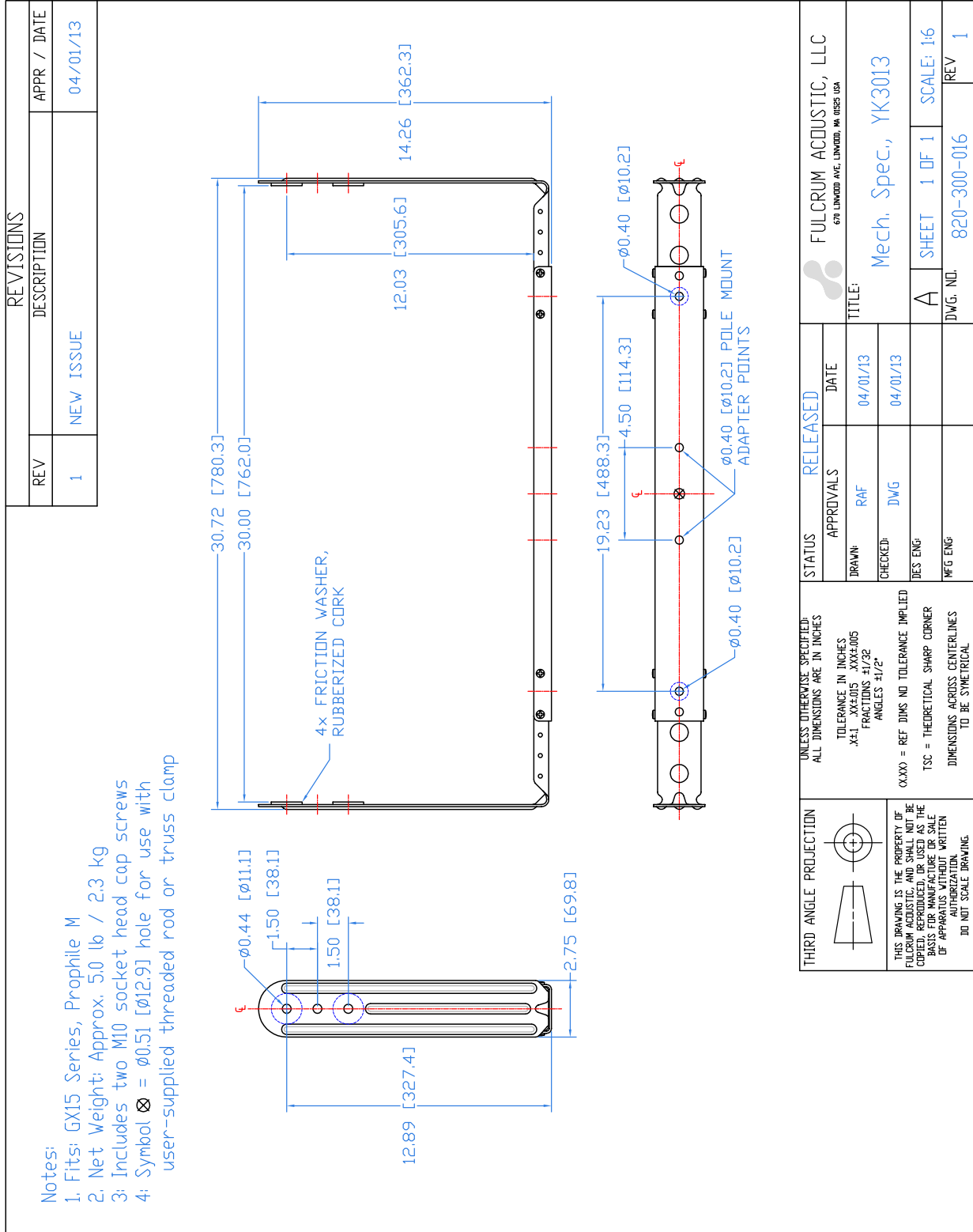

Drawing is reduced. Do not scale.

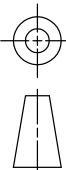
THIRD ANGLE PROJECTION	STATUS	RELEASED	APPROVALS	DATE	FULCRUM ACOUSTIC, LLC 679 LINDA RD AVE, LINDA, WA 98525 USA
	DRAWN	RAF	DATE	04/01/13	TITLE: Mech. Spec., YK3013
	CHECKED	DVG	DATE	04/01/13	
UNLESS OTHERWISE SPECIFIED: ALL DIMENSIONS ARE IN INCHES TOLERANCE IN INCHES .X411 .XX4.015 .XX4.005 FRACTIONS +1/32 ANGLES ±1/2° (X.XX) = REF DIMS NO TOLERANCE IMPLIED TSC = THEORETICAL SHARP CORNER DIMENSIONS ACROSS CENTERLINES TO BE SYMMETRICAL DO NOT SCALE DRAWING.					
			SHEET	1 OF 1	SCALE: 1:6
			DWG. NO.	820-300-016	
			REV	1	