

# FA28

Dual 8 inch Coaxial Loudspeaker

faPORTABLE.



## Overview

The FA28 is a portable, 3-way coaxial loudspeaker that is well suited for a variety of sound reinforcement applications. Its neodymium coaxial transducer and 90° x 60° horn provide broad coverage that is beneficial in both stage monitor and mains operation, and its dedicated neodymium low frequency transducer provides additional low frequency directivity and mid bass impact. Its multi-faceted, enclosure includes a pole mount socket, 40° and 50° rear angles for stage monitor use, and M10 threaded accessory plates for use with optional suspension hardware such as the FA28 Yoke Bracket.

The compact enclosure is vertically-oriented, but if a horizontal orientation is desired, it can be easily obtained by exchanging the pole socket with one of the M10 accessory plates and rotating the coaxial transducer to provide appropriate coverage angles. When rotated, the FA28's low profile also makes it very useful as a high output front fill system when placed on the edge of a stage apron.

Fulcrum Acoustic's **TQ™** processing is an integral part of the FA28 design. Sound, innovative acoustical design combined with state of the art digital processing leads to exceptional clarity and precise transient response, even at high sound pressure levels. The required digital signal processing can be provided by one of many supported platforms. Free air and stage monitor presets are available for all platforms.

The FA28 provides big sound in very small package, and 31 Hz extension is possible when it is paired with the ultra-compact TS212 dual 12 inch subwoofer. This system's combination of high performance, labor saving portability, and aesthetic appeal represents an ideal solution for corporate A/V, television/radio productions, theatrical productions, nightclub PA, portable DJ systems, and more.

## Performance Specifications<sup>1</sup>

### Operating Mode

Single-amplified w/ DSP

### Operating Range<sup>2</sup>

48 Hz to 20 kHz

### Nominal Beamwidth (rotatable)

90° x 60°

### Transducers

LF: 8.0" ceramic magnet woofer, 2.0" voice coil  
HF/LF: Coaxial 1.7" titanium diaphragm compression driver; 8.0" woofer, 2.0" voice coil; single neodymium magnet

### Power Handling @ Nominal Impedance<sup>3</sup>

63 V / 500 W @ 8 Ω

### Nominal Sensitivity @ Input Voltage<sup>4</sup> (whole space)

100 dB @ 2.83 V

### Nominal Maximum SPL (peak / continuous)

133 dB / 127 dB

### Equalized Sensitivity @ Input Voltage<sup>5</sup>

95 dB @ 2.83 V

### Equalized Maximum SPL<sup>6</sup> (peak / continuous)

128 dB / 122 dB

### Recommended Power Amplifier

500 W to 1000 W @ 8 Ω

## Physical Specifications

### Connections

(2) Neutrik NL4 Speakon  
Pin 1+/-: Full Range  
Pin 2+/-: NC

### Mounting / Suspension Points

(1) 35 mm / 1.38 inch pole socket  
(2) M10 nut plates  
(3) M10 accessory plates\*

\*M10 thread is sealed. Use bolts with 15-20 mm shank length.

### Dimensions / Weight

See page 5

### Finish

Black painted enclosure w/ matte black grille

## Options

FA28 Padded Bag w/ Logo  
FA28 Vertical Yoke Bracket (see page 6)  
FA28 Horizontal Yoke Bracket (see page 7)  
SPL Speaker Pole

Mounts to subwoofers with M20-threaded connector plate.  
Height-adjustable between 905 mm / 35.6 in and 1450 mm / 57.1 in



Axial Sensitivity (dB SPL, 2.83 V @ 1 m)<sup>7,8</sup>

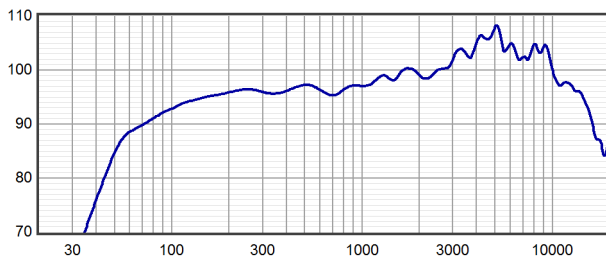

Horizontal Off Axis Response<sup>7,11</sup>

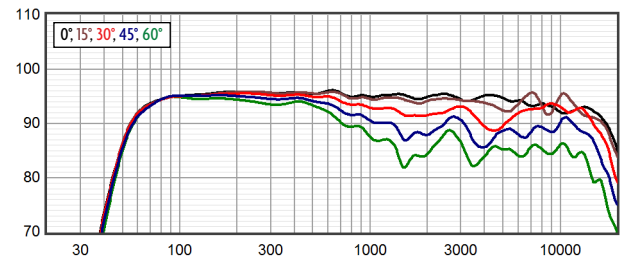

Axial Processed Response (dB)<sup>7,9</sup>

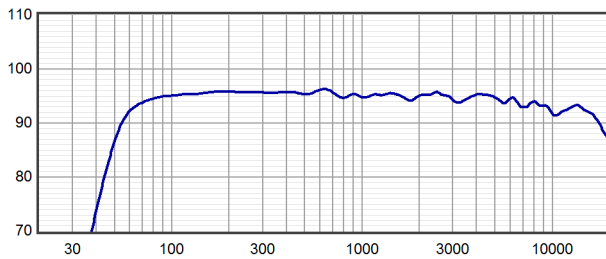

Vertical Off Axis Response<sup>7,11</sup>

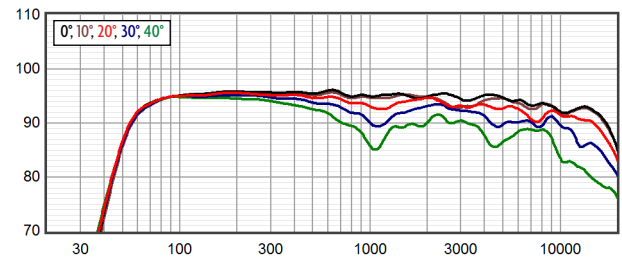

Axial Processed Phase Response (degrees)<sup>7,10</sup>

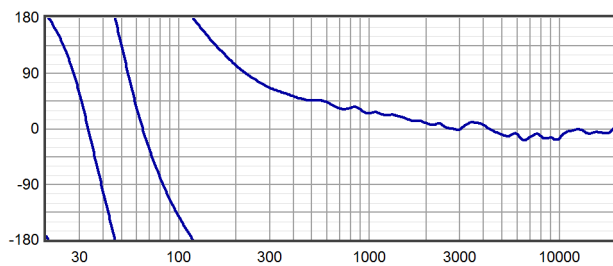

Beamwidth<sup>7,12</sup>

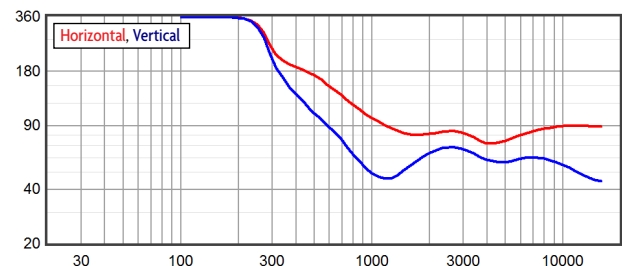

Impedance (ohms)

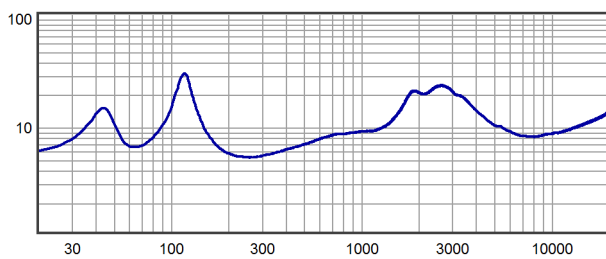

Directivity Index (dB)<sup>3</sup>

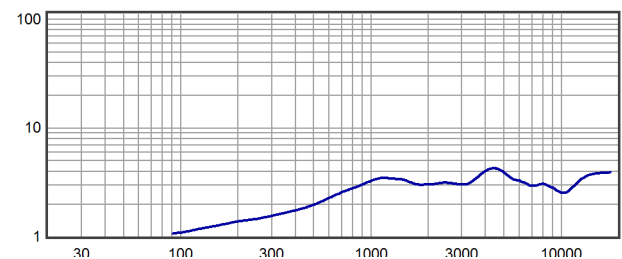



Horizontal Polar Response (30 dB Scale, 6 dB per Major Division)

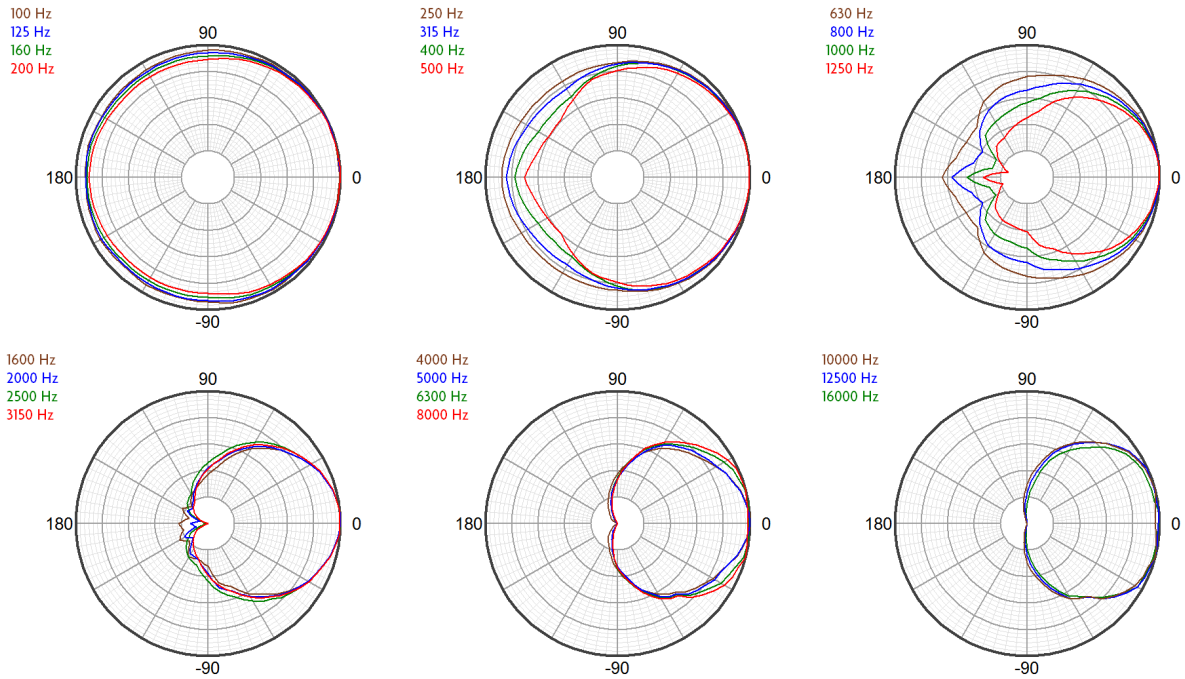

Vertical Polar Response (30 dB Scale, 6 dB per Major Division)

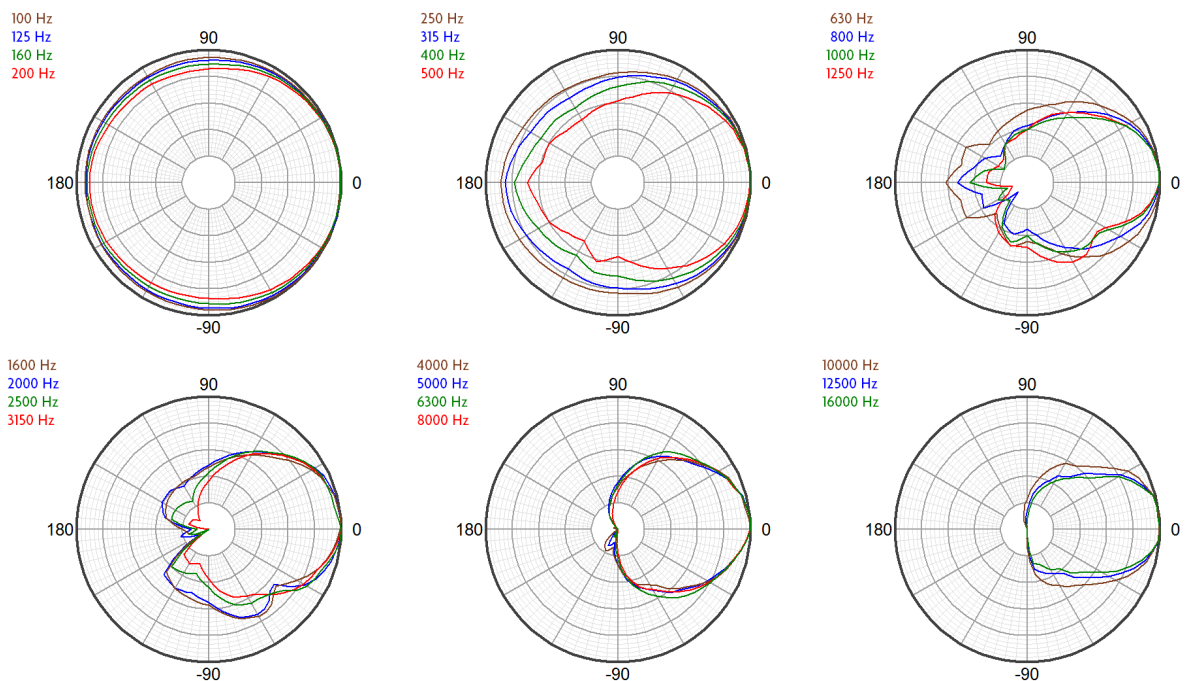



### Technologies

The FA28 includes a neodymium based coaxial driver, which allows the compression driver diaphragm to be positioned very close to the woofer voice coil. This allows the system to maintain coherent summation and consistent off axis response through a 3-way passive crossover, allowing it to be driven with a single amplifier channel.

The compression driver's 1.75 inch diameter diaphragm operates to a relatively low frequency. This allows the high frequency horn to smooth the polar response of the low frequency section in the frequency range where the horn would otherwise cause shadowing. The coaxial woofer's large radiating surface works in conjunction with the HF horn to improve directional control at the low

frequency limit of the horn's operating range, increasing directional control beyond what can be accomplished by the horn alone.

The two low frequency devices both operate down to the lowest frequencies, resulting in mutual coupling that provides unusually high efficiency and impact in the critical 80 Hz to 500 Hz range.

The FA28's unique **TQPassive™** internal crossover is designed to work in conjunction with **TQ™** processing. It provides the high efficiency, excellent damping, and precise directional control normally associated with bi-amplified operation, but it does not require a second amplifier and processor channel. There are no resistive components in the crossover to heat up, so its response remains consistent even at high levels.

### Connection Diagram

3-way, Single-Amp

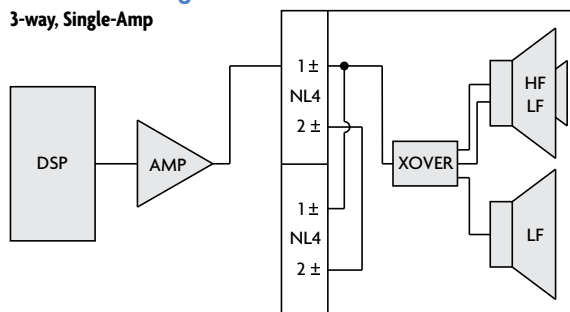

### Mechanical Specification Drawings

2D and 3D DXF dimensional drawings are available for download at [www.fulcrum-acoustic.com/support](http://www.fulcrum-acoustic.com/support).

### Notes

- <sup>1</sup> **Performance Specifications** All acoustic specifications rounded to nearest whole number. External DSP with Fulcrum Acoustic-provided settings is required to achieve the specified performance.
- <sup>2</sup> **Operating Range** The frequency range within which the processed response is within 10 dB of the average.
- <sup>3</sup> **Power Handling** Based on the AES power handling of the transducers.
- <sup>4</sup> **Nominal Sensitivity** The 1-meter-referenced SPL produced by a 1 watt band limited pink noise signal, with no processing applied.
- <sup>5</sup> **Equalized Sensitivity** The 1-meter-referenced SPL produced when an EIA-426-B signal is applied to an equalized loudspeaker system, at a level which produces a total power of 1 watt, in sum, to the loudspeaker subsections.
- <sup>6</sup> **Equalized Maximum SPL** The 1-meter-referenced SPL produced when an EIA-426-B signal is applied to an equalized loudspeaker system, at a level which drives at least one subsection to its rated power.
- <sup>7</sup> **Resolution** All response graphs are subjected to 1/6 octave cepstral smoothing with a gaussian weighting function.
- <sup>8</sup> **Axial Sensitivity** The SPL plotted against frequency for a 1 watt swept sine wave, referenced to 1 m with no signal processing.
- <sup>9</sup> **Axial Processed Response** The axial magnitude response with recommended signal processing applied.
- <sup>10</sup> **Axial Processed Phase Response** The axial phase response with recommended signal processing applied, and latency removed.
- <sup>11</sup> **Horizontal / Vertical Off Axis Responses** The magnitude response at various angles off axis, with recommended signal processing applied.
- <sup>12</sup> **Beamwidth** The angle between the -6 dB points in a loudspeaker's polar response.
- <sup>13</sup> **Directivity Index (Di)** The ratio of the on-axis sound pressure squared to the spherical average of the sound pressure squared at a particular frequency expressed in dB. To convert the directivity index to directivity factor (Q) use the formula  $10^{Di/10}$ .

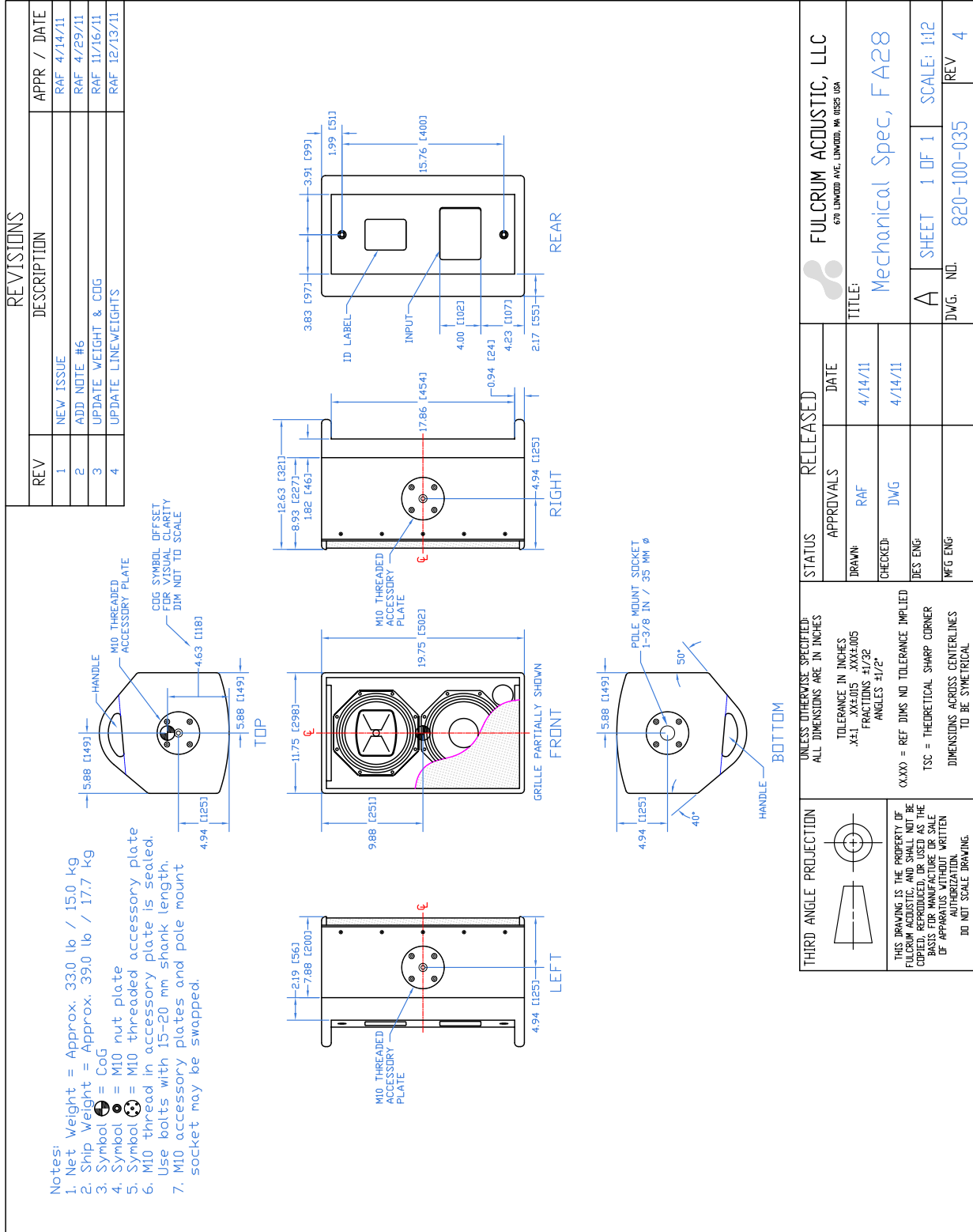

Drawing is reduced. Do not scale.



optional accessory

**NOTES::**

- FITS: FA28, FA28ac
- WEIGHT: 6.0 lb / 2.7 kg
- INCLUDES TWO M10 THREADED KNOBS AND TWO QUICK RELEASE PINS
- SYMBOL  $\otimes$  =  $\varnothing 0.51$  [ $\varnothing 12.9$ ] HOLE FOR USE WITH USER-SUPPLIED THREADED ROD OR TRUSS CLAMP

MAY BE COLLAPSED FOR TRANSPORT

REVISIONS		
REV	DESCRIPTION	APPR / DATE
1	NEW ISSUE	RAF 4/18/14

POLE MOUNT ADAPTER POINTS  
4x 0.40 [ $\varnothing 10.2$ ]

FRICTION WASHER, RUBBERIZED CORK

**INSTALLATION:**

- REMOVE ONE QUICK RELEASE PIN, SWING ARM OUT
- SCREW OTHER ARM INTO M10 ACCESSORY PLATE
- SWING FIRST ARM DOWN, SCREW INTO SECOND M10 ACCESSORY PLATE
- INSERT QUICK RELEASE PIN REMOVED IN STEP ONE
- TILT LOUDSPEAKER TO DESIRED ANGLE AND TIGHTEN BOTH KNOBS

THIRD ANGLE PROJECTION

THIS DRAWING IS THE PROPERTY OF FULCRUM ACOUSTIC, AND SHALL NOT BE COPIED, REPRODUCED, OR USED AS THE BASIS FOR MANUFACTURE OR SALE OF APPARATUS WITHOUT WRITTEN AUTHORIZATION. DO NOT SCALE DRAWING.

UNLESS OTHERWISE SPECIFIED:  
ALL DIMENSIONS ARE IN INCHES

TOLERANCE IN INCHES  
.XX±.015 .XXX±.005  
FRACTIONS ±1/32  
ANGLES ±1/2°

(X.XX) = REF DIMS NO TOLERANCE IMPLIED

TSC = THEORETICAL SHARP CORNER

DIMENSIONS ACROSS CENTERLINES TO BE SYMMETRICAL

STATUS: RELEASED

APPROVALS	DATE
DRAWN: RAF	4/18/14
CHECKED: DWG	4/18/14
DES ENG:	
MFG ENG:	

FULCRUM ACOUSTIC, LLC  
670 LINWOOD AVE, LINWOOD, MA 01525 USA

TITLE: Mechanical Spec,  
FA28 Vert. Yoke Bracket

A SHEET 1 OF 1 SCALE: 1:12

DWG. NO. 820-300-019 REV 1

Drawing is reduced. Do not scale.



optional accessory

REVISIONS		
REV	DESCRIPTION	APPR / DATE
1	NEW ISSUE	RAF 4/18/14

**NOTES:**

- FITS: FA28, FA28ac
- WEIGHT: 6.0 lb / 2.7 kg
- INCLUDES TWO M10 THREADED KNOBS AND TWO QUICK RELEASE PINS
- SYMBOL  $\otimes$  =  $\varnothing 0.51$  [ $\varnothing 12.9$ ] HOLE FOR USE WITH USER-SUPPLIED THREADED ROD OR TRUSS CLAMP

MAY BE COLLAPSED FOR TRANSPORT

POLE MOUNT ADAPTER POINTS  
4x 0.40 [ $\varnothing 10.2$ ]

**INSTALLATION:**

- REMOVE ONE QUICK RELEASE PIN, SWING ARM OUT
- SCREW OTHER ARM INTO M10 ACCESSORY PLATE
- SWING FIRST ARM DOWN, SCREW INTO SECOND M10 ACCESSORY PLATE
- INSERT QUICK RELEASE PIN REMOVED IN STEP ONE
- TILT LOUSPEAKER TO DESIRED ANGLE AND TIGHTEN BOTH KNOBS

<p>THIRD ANGLE PROJECTION</p>	<p>UNLESS OTHERWISE SPECIFIED: ALL DIMENSIONS ARE IN INCHES</p> <p>TOLERANCE IN INCHES .X±.1 .XX±.015 .XXX±.005 FRACTIONS ±1/32 ANGLES ±1/2°</p> <p>(XXX) = REF DIMS NO TOLERANCE IMPLIED</p> <p>TSC = THEORETICAL SHARP CORNER</p> <p>DIMENSIONS ACROSS CENTERLINES TO BE SYMMETRICAL</p>	STATUS RELEASED		<p>FULCRUM ACOUSTIC, LLC 670 LINWOOD AVE, LINWOOD, MA 01525 USA</p>	
		APPROVALS	DATE		TITLE: Mechanical Spec, FA28 Horz. Yoke Bracket
<p>THIS DRAWING IS THE PROPERTY OF FULCRUM ACOUSTIC, AND SHALL NOT BE COPIED, REPRODUCED, OR USED AS THE BASIS FOR MANUFACTURE OR SALE OF APPARATUS WITHOUT WRITTEN AUTHORIZATION. DO NOT SCALE DRAWING.</p>		DRAWN: RAF	4/18/14	SHEET 1 OF 1	SCALE: 1:12
		CHECKED: DWG	4/18/14	A	
		DES ENG:			DWG. NO. 820-300-022
		MFG ENG:			

Drawing is reduced. Do not scale.