



# CX896

## 8 inch Coaxial Loudspeaker

*tq* install™  
SERIES



### Overview

The CX896 is a coaxial loudspeaker that provides the output capability of a traditional 8 inch 2-way, horn-loaded-HF loudspeaker, but in a much more compact enclosure. Its coaxial transducer can be rotated in 45° increments, which allows its coverage to be tailored to best suit an application's requirements. The enclosure's 30° vertically trapezoidal shape allows mounting very close to ceilings or under balconies with minimal effect on sight lines.

Fulcrum Acoustic's **TQ™** processing is an integral part of the CX896 design. Sound, innovative acoustical design combined with state of the art digital processing leads to exceptional clarity and precise transient response, even at very high sound pressure levels. The required digital signal processing can be provided by one of many supported platforms.

The CX896's 90° x 60° high frequency horn is particularly effective for fill systems where targeted pattern control is desirable.

In addition, its 16 ohm nominal impedance makes it an excellent solution for high fidelity, foreground distributed systems where a high loudspeaker-to-amplifier ratio is desirable.

### Performance Specifications<sup>1</sup>

#### Operating Mode

Single-amplified w/ DSP

#### Operating Range<sup>2</sup>

84 Hz to 20 kHz

#### Nominal Beamwidth (rotatable)

90° x 60°

#### Transducers

HF/LF: Coaxial 1.7" titanium diaphragm compression driver; 8.0" woofer, 2.0" voice coil; single neodymium magnet

#### Power Handling @ Nominal Impedance<sup>3</sup>

63 V / 250 W @ 16 Ω

#### Nominal Sensitivity @ Input Voltage<sup>4</sup> (whole space)

103 dB @ 4.00 V

#### Nominal Maximum SPL (peak / continuous)

133 dB / 127 dB

#### Equalized Sensitivity @ Input Voltage<sup>5</sup>

95 dB @ 4.00 V

#### Equalized Maximum SPL<sup>6</sup> (peak / continuous)

125 dB / 119 dB

#### Recommended Power Amplifier

250 W to 500 W @ 16 Ω

### Physical Specifications

#### Connections

(2) Neutrik NL4 Speakon

Pin 1+/-: Full Range

Pin 2+/-: NC

#### Mounting / Suspension Points

(2) M6 yoke points, (2) M6 pull back points

#### Dimensions / Weight

See page 5

#### Finish

Black painted enclosure w/ matte black grille, or

White painted enclosure w/ matte white grille

### Options

CX896 U Bracket [YK1408], Terminal strip input,

Custom color finish, Weather-resistant (WR) enclosure



Axial Sensitivity (dB SPL, 4.00 V @ 1 m)<sup>7,8</sup>

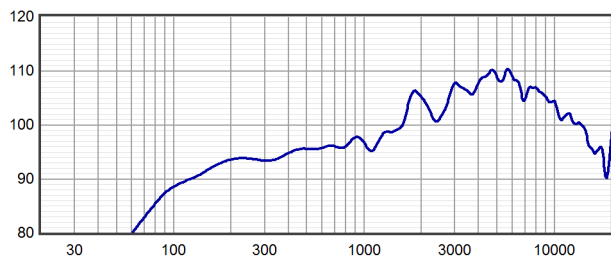

Horizontal Off Axis Response<sup>7,11</sup>

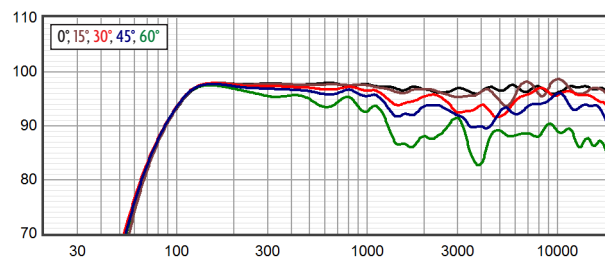

Axial Processed Response (dB)<sup>7,9</sup>

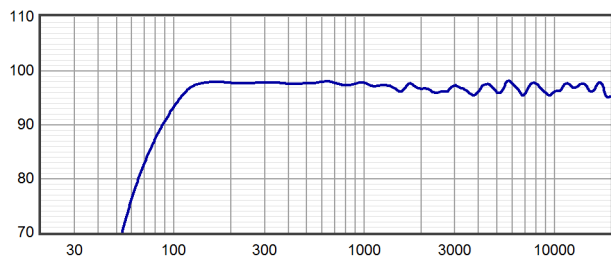

Vertical Off Axis Response<sup>7,11</sup>

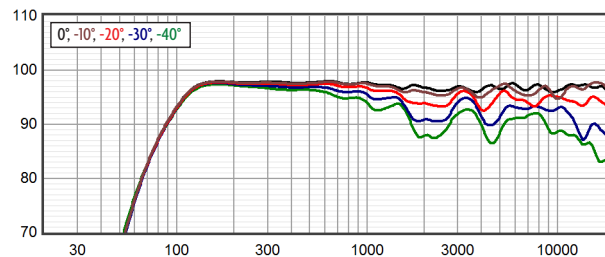

Axial Processed Phase Response (degrees)<sup>7,10</sup>

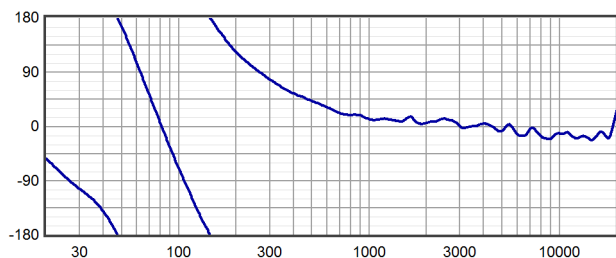

Beamwidth<sup>7,12</sup>

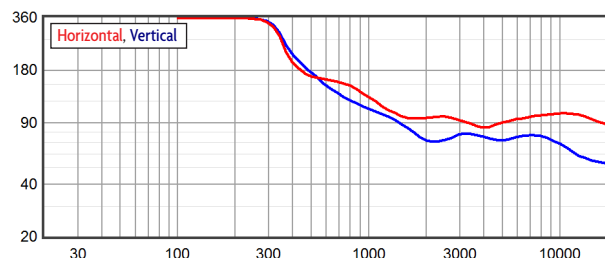

Impedance (ohms)

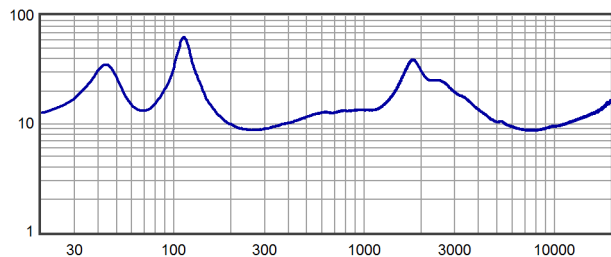

Directivity Index (dB)<sup>13</sup>

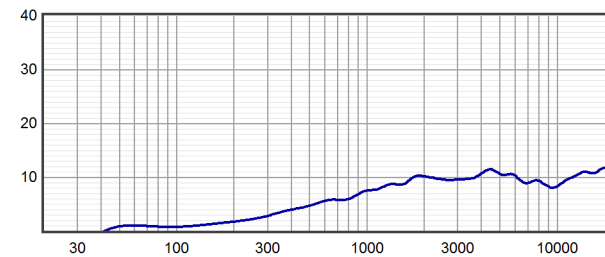



product specification

Horizontal Polar Response (30 dB Scale, 6 dB per Major Division)

100 Hz  
125 Hz  
160 Hz  
200 Hz

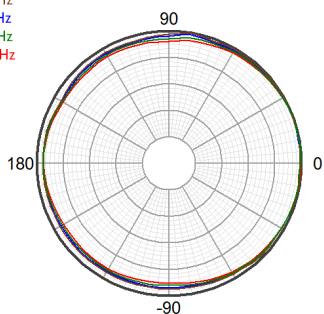

250 Hz  
315 Hz  
400 Hz  
500 Hz

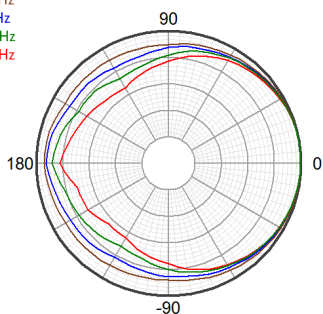

630 Hz  
800 Hz  
1000 Hz  
1250 Hz

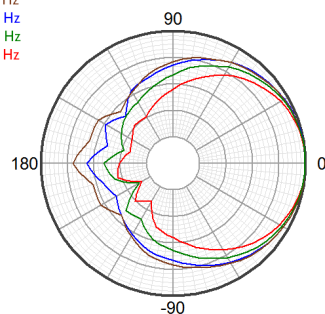

1600 Hz  
2000 Hz  
2500 Hz  
3150 Hz

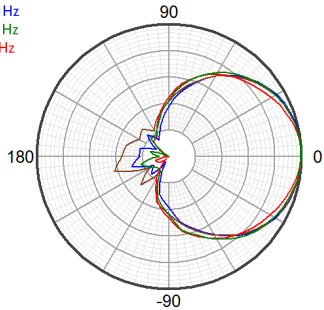

4000 Hz  
5000 Hz  
6300 Hz  
8000 Hz

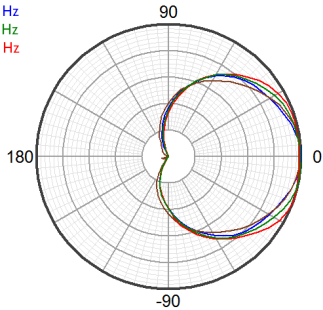

10000 Hz  
12500 Hz  
16000 Hz  
20000 Hz

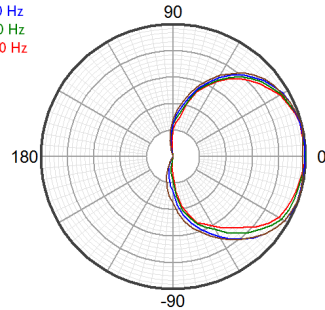

Vertical Polar Response (30 dB Scale, 6 dB per Major Division)

100 Hz  
125 Hz  
160 Hz  
200 Hz

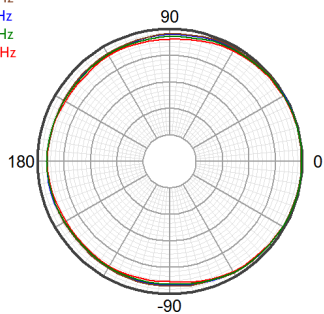

250 Hz  
315 Hz  
400 Hz  
500 Hz

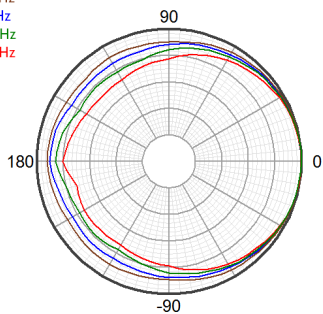

630 Hz  
800 Hz  
1000 Hz  
1250 Hz

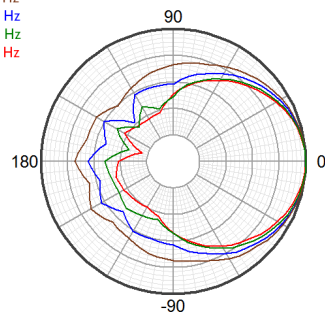

1600 Hz  
2000 Hz  
2500 Hz  
3150 Hz

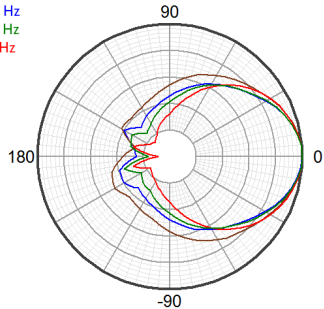

4000 Hz  
5000 Hz  
6300 Hz  
8000 Hz

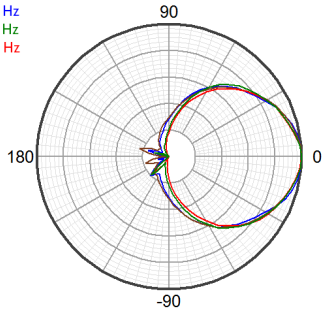

10000 Hz  
12500 Hz  
16000 Hz  
20000 Hz

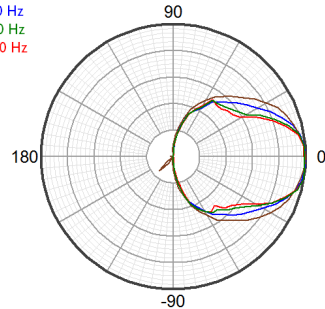



### Technologies

The CX896 includes a neodymium-based coaxial transducer which allows the compression driver diaphragm to be positioned very close to the woofer voice coil. This allows the system to maintain coherent summation and consistent off axis response through a passive crossover, allowing it to be powered with a single amplifier channel.

The compression driver's 1.75 inch diameter diaphragm operates to a relatively low frequency. This allows the high frequency horn to smooth the polar response of the low frequency section in the frequency range where the horn would otherwise cause shadowing. The coaxial woofer's large radiating surface works in conjunction with the HF horn to improve directional control at the low frequency limit of the horn's operating range, increasing directional control beyond what can be accomplished by the horn alone.

### Connection Diagram

2-way, Single-Amp

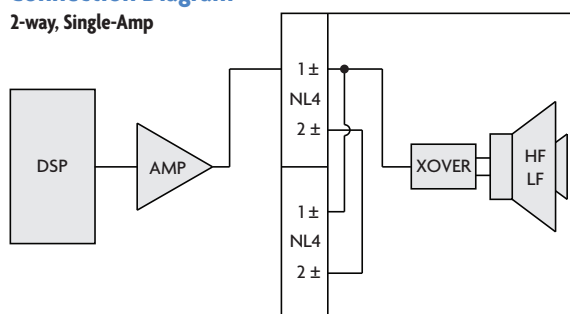

### Mechanical Specification Drawings

2D and 3D DXF dimensional drawings are available for download at [www.fulcrum-acoustic.com/support](http://www.fulcrum-acoustic.com/support).

### Notes

- <sup>1</sup> **Performance Specifications** All acoustic specifications rounded to nearest whole number. External DSP with Fulcrum Acoustic-provided settings is required to achieve the specified performance.
- <sup>2</sup> **Operating Range** The frequency range within which the processed response is within 10 dB of the average.
- <sup>3</sup> **Power Handling** Based on the AES power handling of the transducers.
- <sup>4</sup> **Nominal Sensitivity** The 1-meter-referenced SPL produced by a 1 watt band limited pink noise signal, with no processing applied.
- <sup>5</sup> **Equalized Sensitivity** The 1-meter-referenced SPL produced when an EIA-426-B signal is applied to an equalized loudspeaker system, at a level which produces a total power of 1 watt, in sum, to the loudspeaker subsections.
- <sup>6</sup> **Equalized Maximum SPL** The 1-meter-referenced SPL produced when an EIA-426-B signal is applied to an equalized loudspeaker system, at a level which drives at least one subsection to its rated power.
- <sup>7</sup> **Resolution** All response graphs are subjected to 1/6 octave cepstral smoothing with a gaussian weighting function.
- <sup>8</sup> **Axial Sensitivity** The SPL plotted against frequency for a 1 watt swept sine wave, referenced to 1 m with no signal processing.
- <sup>9</sup> **Axial Processed Response** The axial magnitude response with recommended signal processing applied.
- <sup>10</sup> **Axial Processed Phase Response** The axial phase response with recommended signal processing applied, and latency removed.
- <sup>11</sup> **Horizontal / Vertical Off Axis Responses** The magnitude response at various angles off axis, with recommended signal processing applied.
- <sup>12</sup> **Beamwidth** The angle between the -6 dB points in a loudspeaker's polar response.
- <sup>13</sup> **Directivity Index (Di)** The ratio of the on-axis sound pressure squared to the spherical average of the sound pressure squared at a particular frequency expressed in dB. To convert the directivity index to directivity factor (Q) use the formula  $10^{Di/10}$ .



product specification

Notes:

1. Net Weight = Approx. 17.0 lb / 7.7 kg
2. Ship Weight = Approx. 22.0 lb / 10.0 kg
3. Symbol = M6 nut plate
4. Symbol = CoG

REVISIONS		
REV	DESCRIPTION	APPR / DATE
1	RELEASE TO PRODUCTION	RAF 11/6/09
2	CORRECT REAR HEIGHT DIMENSION	RAF 12/11/09
3	ADD SHIPPING WEIGHT	RAF 12/5/11
4	OMNIMOUNT TO "THIRD PARTY" IN NOTE 4	RAF 1/13/12
5	REMOVE PAN/TILT MOUNT POINTS	RAF 7/28/16

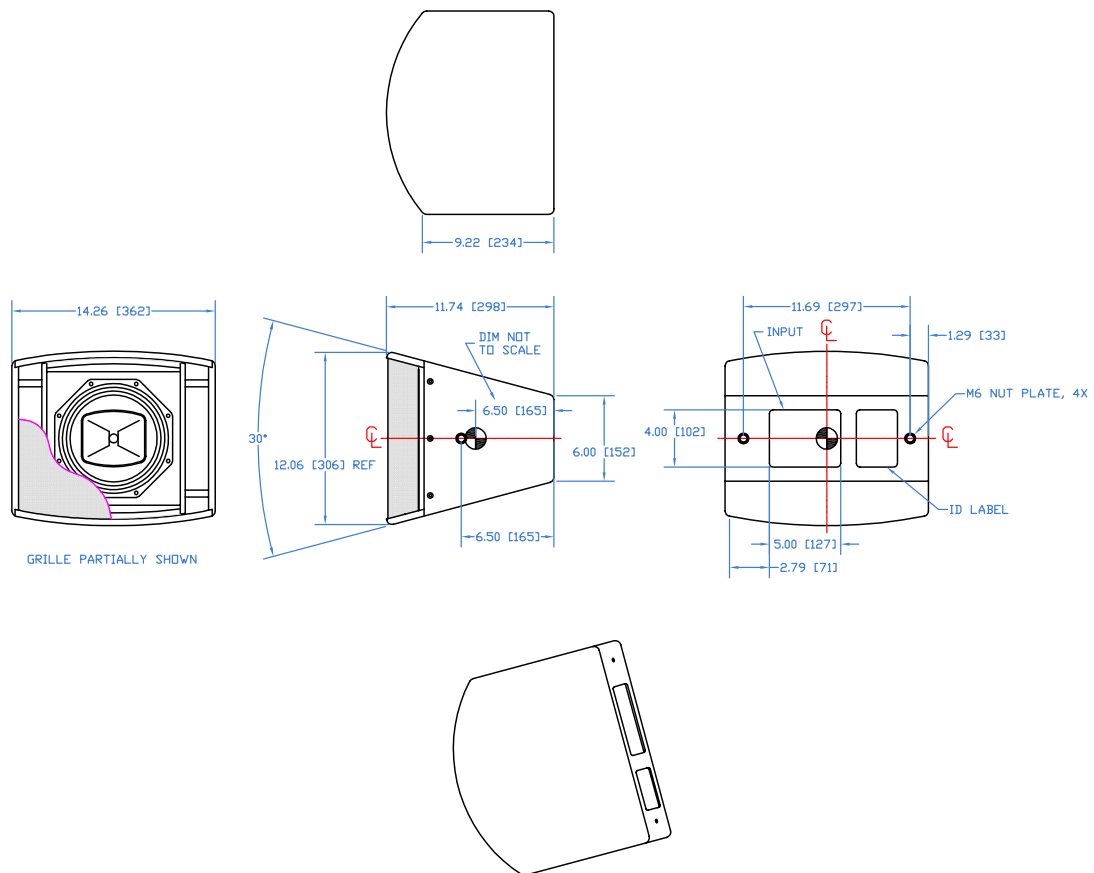

<p>THIRD ANGLE PROJECTION</p>	<p>UNLESS OTHERWISE SPECIFIED: ALL DIMENSIONS ARE IN INCHES</p> <p>TOLERANCE IN INCHES .X±.1 .XX±.015 .XXX±.005 FRACTIONS ±1/32 ANGLES ±1/2°</p> <p>(X.XX) = REF DIMS NO TOLERANCE IMPLIED</p> <p>TSC = THEORETICAL SHARP CORNER</p> <p>DIMENSIONS ACROSS CENTERLINES TO BE SYMMETRICAL</p>	<p>STATUS RELEASED</p>		<p>FULCRUM ACOUSTIC, LLC 670 LINWOOD AVE, LINWOOD, MA 01525 USA</p>	
		<p>APPROVALS</p> <p>DRAWN: DWG</p> <p>CHECKED: RAF</p> <p>DES ENG:</p> <p>MFG ENG:</p>	<p>DATE</p> <p>2/10/09</p> <p>6/12/09</p>	<p>TITLE: Mechanical Spec, CX896</p>	
<p>THIS DRAWING IS THE PROPERTY OF FULCRUM ACOUSTIC, AND SHALL NOT BE COPIED, REPRODUCED, OR USED AS THE BASIS FOR MANUFACTURE OR SALE OF APPARATUS WITHOUT WRITTEN AUTHORIZATION. DO NOT SCALE DRAWING.</p>			<p>DWG. NO. 820-100-026</p>		<p>SCALE: 1:12</p> <p>REV 5</p>

Drawing is reduced. Do not scale.



product specification, weather-resistant (WR) version

Notes:

1. Net Weight = Approx. 17.5 lb / 7.9 kg
2. Ship Weight = Approx. 22.5 lb / 10.2 kg
3. Symbol = M6 nut plate
- 5: Symbol = CoG

REVISIONS		
REV	DESCRIPTION	APPR / DATE
1	NEW ISSUE	RAF 3/19/15
2	ADD COVER PLATE DETAIL	RAF 12/01/15
3	REMOVE PAN/TILT MOUNT POINTS	RAF 7/28/16

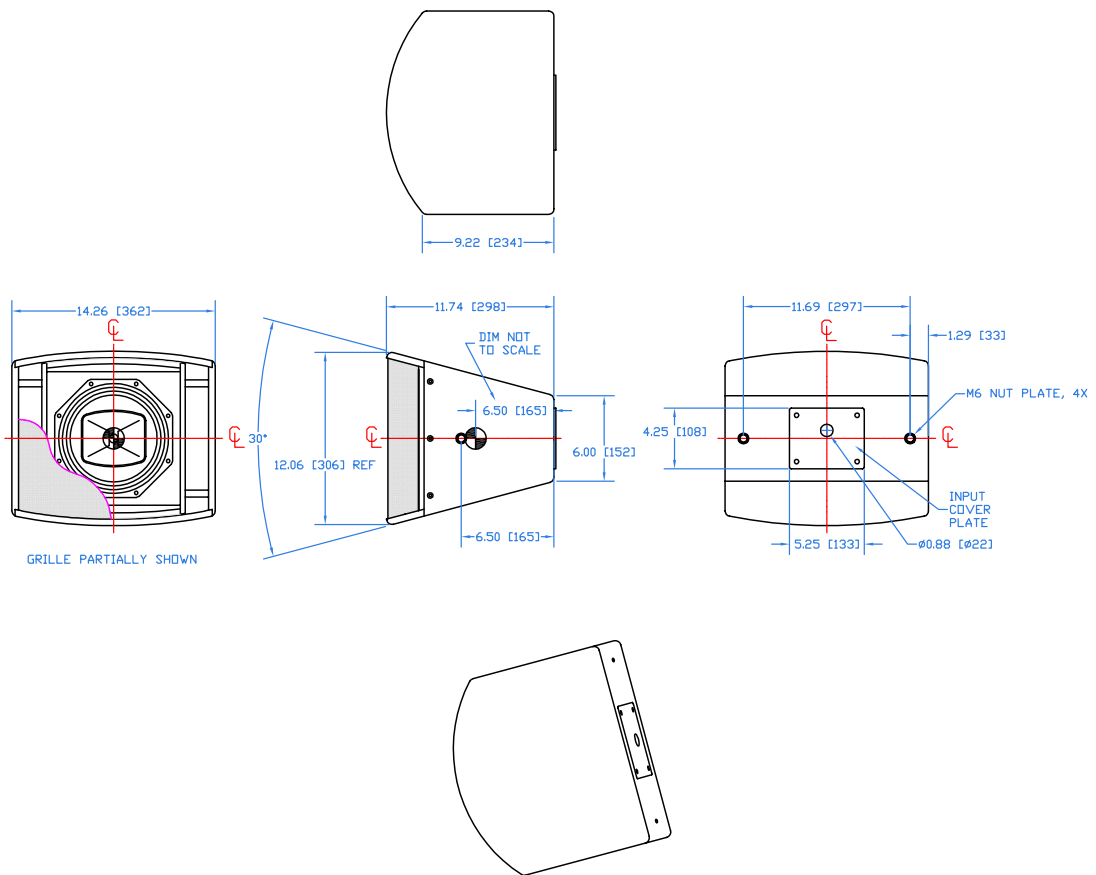

<p>THIRD ANGLE PROJECTION</p>	<p>UNLESS OTHERWISE SPECIFIED: ALL DIMENSIONS ARE IN INCHES</p> <p>TOLERANCE IN INCHES .X±.1 .XX±.015 .XXX±.005 FRACTIONS ±1/32 ANGLES ±1/2°</p> <p>(X.XX) = REF DIMS NO TOLERANCE IMPLIED</p> <p>TSC = THEORETICAL SHARP CORNER</p> <p>DIMENSIONS ACROSS CENTERLINES TO BE SYMMETRICAL</p>	<p>STATUS RELEASED</p>		<p>FULCRUM ACOUSTIC, LLC 670 LINWOOD AVE, LINWOOD, MA 01525 USA</p>
		<p>APPROVALS</p> <p>DRAWN: RAF</p> <p>CHECKED: DWG</p> <p>DES ENG:</p> <p>MFG ENG:</p>	<p>DATE</p> <p>3/19/15</p> <p>3/19/15</p>	
<p>THIS DRAWING IS THE PROPERTY OF FULCRUM ACOUSTIC, AND SHALL NOT BE COPIED, REPRODUCED, OR USED AS THE BASIS FOR MANUFACTURE OR SALE OF APPARATUS WITHOUT WRITTEN AUTHORIZATION. DO NOT SCALE DRAWING.</p>			<p>DWG. NO. 820-100-084</p>	<p>SCALE: 1:12</p> <p>REV 3</p>

Drawing is reduced. Do not scale.

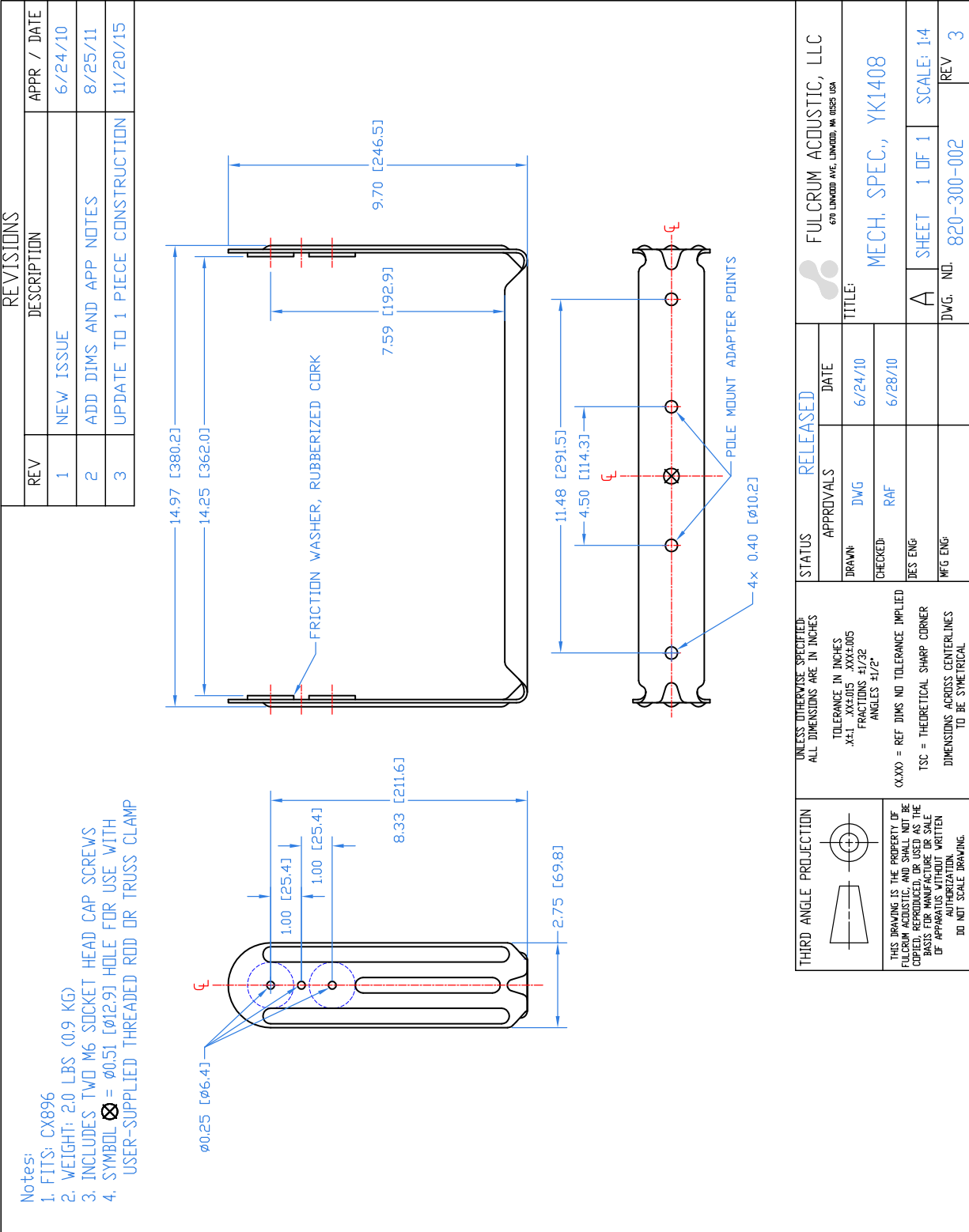

Drawing is reduced. Do not scale.